

EU-Type Examination Certificate

Measuring Instrument Directive

Certificate number: DK-0200-MI004-034

Issued by FORCE Certification A/S, Denmark
EU-notified body number 0200

In accordance with the Danish Safety Technology Authority's statutory order no. 544 of May 28, 2018 which implements the Directive 2014/32/EU of the European Parliament and Council of February 26, 2014 on measuring instruments (MID).

Issued to: **Danfoss A/S**
 Nordborgvej 81
 DK - 6430 Nordborg
 Denmark

Type of instrument: Energy Meter, complete meter

Type designation: SonoSelect 10 and SonoSafe 10 Heat meter

Valid until: 06-11-2025

Number of pages: 26, including appendix

Date of issue: 10-07-2019

Version No.: 10
This new version of DK-0200-MI004-034 is issued due to changes to the product.
The previous certificate is withdrawn.

Approved by

Michael Møller Nielsen
Certification Manager

Processed by

Lars Poder
Examiner

The conformity markings may only be affixed to the above type approved equipment. The manufacturer's Declaration of Conformity may only be issued and the notified body identification number may only be affixed on the instrument when the production/product assessment module (D or F) of the directive is fully complied with and controlled by a written inspection agreement with a notified body.
This EU-type examination certificate may not be reproduced except in full, without written permission by FORCE Certification A/S.

FORCE Certification references: TASK no.: 118-36821.02 and ID no.: 0200-MID-06902

Appendix to

EU-Type Examination Certificate Measuring Instrument Directive

Number: DK-0200-MI004-034

Issued by FORCE Certification A/S, Denmark

EU-notified body number 0200

Revision	Issue date	Changes
DK-0200-MI004-034	06-11-2015	<ul style="list-style-type: none"> ▪ Original certificate
DK-0200-MI004-034 rev. 1	27-11-2015	<ul style="list-style-type: none"> ▪ New hardware and new firmware added
DK-0200-MI004-034 rev. 2	12-02-2016	<ul style="list-style-type: none"> ▪ New firmware added ▪ Improvements added to verification section ▪ New photo and new label added ▪ Various textual changes
DK-0200-MI004-034 Ver. 3	02-03-2017	<ul style="list-style-type: none"> ▪ Changed Heat meter to Energy meter ▪ New firmware added ▪ Temperature verification section removed ▪ Energy verification updated with extra temperatures ▪ New photo and new label added ▪ Various textual changes
DK-0200-MI004-034 Ver. 4	02-06-2017	<ul style="list-style-type: none"> ▪ DN25 qp6.0 added ▪ DN32 qp6.0 added ▪ New hardware issue added
DK-0200-MI004-034 Ver. 5	15-09-2017	<ul style="list-style-type: none"> ▪ New pulse output module added ▪ Comment on passed durability tests added
DK-0200-MI004-034 Ver. 6	07-02-2018	<ul style="list-style-type: none"> ▪ New hardware issue and part numbers added ▪ New firmware added ▪ Bifunctional meter setup added
DK-0200-MI004-034 Ver. 7	14-05-2018	<ul style="list-style-type: none"> ▪ New firmware added ▪ New hardware issue added
DK-0200-MI004-034 Ver. 8	24-08-2018	<ul style="list-style-type: none"> ▪ Mains powered variant added
DK-0200-MI004-034 Ver. 9	14-03-2019	<ul style="list-style-type: none"> ▪ PN25 130 °C variant added ▪ Specific hardware part numbers removed
DK-0200-MI004-034 Ver. 10	10-07-2019	<ul style="list-style-type: none"> ▪ New firmware added

Applied standards and documents:

EN 1434-4:2015 + A1:2018

The instruments/measuring systems shall correspond with the following specifications.

Type designation:

SonoSelect 10 and SonoSafe 10.

DK-0200-MI004-034

Description:

Danfoss SonoSelect and SonoSafe are battery or mains powered ultrasonic compact energy meters intended for measuring energy consumption in heating applications for billing purposes. The two meters are identically designed and with identical firmware but are configured differently. The meters consist of a flow sensor, a pair of Pt1000 temperature sensors and a calculator with integrated circuits for temperature measurement, flow measurement and energy calculation. There is one main PCBA with a display, a push button, a μ C and an optical communication facility.

The flow sensor consists of a meter body made of brass and is based on the ultrasonic principle with no moving parts. The flow velocity is derived from difference time and speed of sound measurements.

The calculator is part of the main PCBA and includes either wired M-Bus communication, or no communication. Various communication- and input-/output- modules can be connected to main PCBA. The electrical connection between the calculator and the flow sensor is typically a 0.5 m long cable for SonoSafe 10 and 1.5 m for SonoSelect 10. The cables may be longer but shall be shorter than 10 m. The Pt1000 temperature sensor cables are typically 1.5 m long. The cables may be longer but shall be shorter than 10 m.

Technical documentation:

Reference no.:

- 118-36821.01
- 118-22308.03
- 118-22308.02
- 118-22308.01
- 117-22138.03
- 117-22138.02
- 117-22138.01
- 116-20827.10.01
- 114-30572.10
- 114-30572

Technical data

General

Instrument type according to:	EN 1434-4:2015 + A1:2018
Instrument types:	Heat and bifunctional meter Complete instrument or Hybrid instrument (An energy meter, which for the purpose of pattern approval and verification can be treated as a combined instrument. However, after verification, its sub-assemblies shall be treated as inseparable)
Sub-assembly for hybrid instrument:	Calculator, flow sensor and temperature sensor pair
Energy indication:	GJ – Gcal – MWh – kWh (Wh in verification mode)
Temperature range:	$\theta_{\min} - \theta_{\max} = 5 \text{ }^{\circ}\text{C} - 95 \text{ }^{\circ}\text{C}$ (standard 95 °C variant) $\theta_{\min} - \theta_{\max} = 5 \text{ }^{\circ}\text{C} - 130 \text{ }^{\circ}\text{C}$ (130 °C variant)
Diff. temperature range:	$\Delta\theta_{\min} - \Delta\theta_{\max} = 3 \text{ K} - 90 \text{ K}$ (standard 95 °C variant) $\Delta\theta_{\min} - \Delta\theta_{\max} = 3 \text{ K} - 125 \text{ K}$ (130 °C variant)
Temperature sensors:	Pt1000 direct short, 2 wire, 1.5 m cable length (The cables may be longer but shall be shorter than 10 m)
Cable length flow sensor/calculator:	1.5 m for SonoSelect and 0.5 m for SonoSafe (The cables may be longer but shall be shorter than 10 m)
Flow sensor, orientation:	Any orientation, no inlet or outlet restrictions
Accuracy class:	2 and 3
Environmental class:	E1, M1, M2 and M3
Ambient temperature:	5 to 55 °C, non-condensing, closed location
Durability specification:	Min. 10 years, based on passed basic durability test, additional durability test and accelerated durability test
Protection class:	IP65 (SonoSelect) / IP54 (SonoSafe)
Power supply:	3.6 V Lithium battery (1 or 2 AA-cells or A-cells) or 230 VAC

General (continued)

Flow sensor sizes	DN	15	15	20	20	20	25	25	25	32
Nominal flow q_p	[m ³ /h]	0.6	1.5	1.5	1.5	2.5	3.5	3.5	6.0	6.0
Maximum flow q_s	[m ³ /h]	1.2	3.0	3.0	3.0	5.0	7.0	7.0	12.0	12.0
Minimum flow q_i	[m ³ /h]	0.006	0.015	0.015	0.015	0.025	0.035	0.035	0.060	0.060
Pressure loss @ q_p	[mbar]	30	150	150	155	160	130	135	220	220
Connection	[Inch]	G ³ / ₄ A		G1 A	G1 A	G1 A	G1 ¹ / ₄ A	G1 ¹ / ₄ A	G1 ¹ / ₄ A	G1 ¹ / ₂ A
Length	[mm]	110		130	190 *1	130	160	260	260	260
Pressure stage	PN[bar]	16 (standard 95 °C variant) 25 (130 °C variant)								

Firmware specification

The approved firmware is identified as:

Version No.	Code No.	Checksum for metrological part of the firmware
01.02.00	014C2600	9329 8405H
01.03.00	014C2620	BD03 F784H
01.05.00	014C2624	84D5 016BH
01.06.00	014C2624	36B6 3DADH
01.06.01	014C2653	E5B2 7F0CH

The firmware version is engraved on the front cover.

All versions will exist in different regions.

Hardware specification

The approved hardware is identified as:

- Main PCBA with integrated MBUS communication.
- Main PCBA without integrated MBUS communication.
- Main PCBA with integrated MBUS communication
Display layout incl. symbols for Bi functional and Mains supply.
- Main PCBA without integrated MBUS communication
Display layout incl. symbols for Bi functional and Mains supply.

¹ The 190 mm variant is made up of one 130 mm flow sensor and one additional 60 mm pipe.

Modules

Several different Modules can be assembled from factory or can be mounted on site.
The Modules are not a legal part of the Energy meter.

Module types:

- 2 Pulse Input
- Wired MBUS with 2 Pulse Input
- Wireless Radio/OMS with 2 Pulse Input
- Wireless Radio/OMS WalkBy with 2 Pulse Input
- 2 Pulse Output

Application drawings

Supply pipe installation.

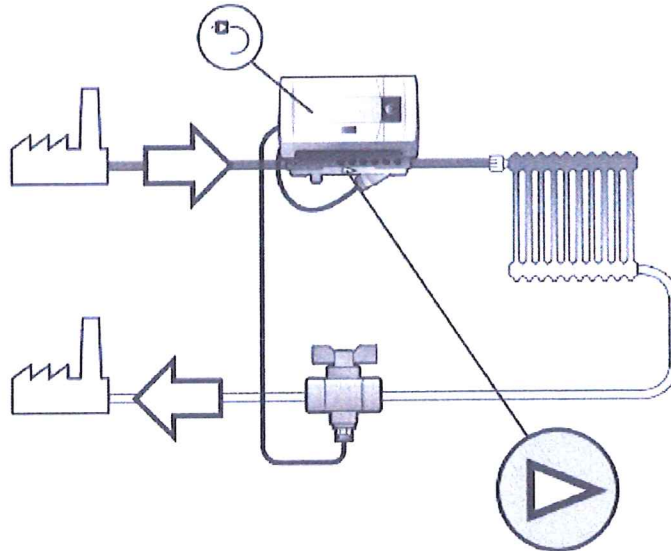

Return pipe installation.

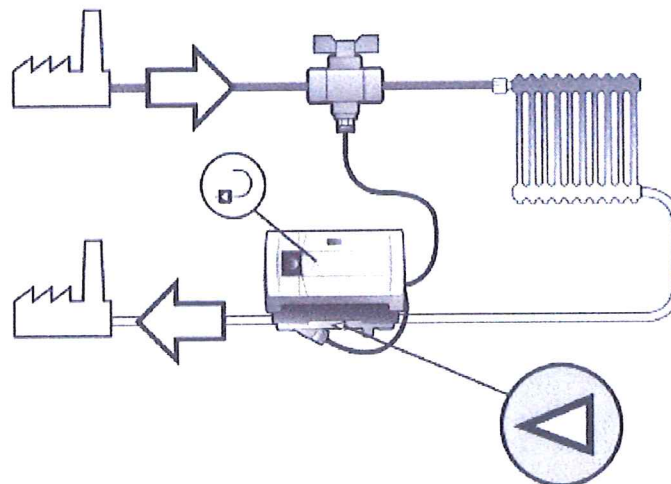

Verification

Test conditions

Make sure that no foreign objects are inside the Flow Sensor.

Mount the Flow Sensor in an angle (45 to 315 deg.) to ensure no air is trapped in front of the Transducers.

Make sure no air is trapped inside the Flow Sensor by flushing the system for several minutes with different flowrates (high and low alterations).

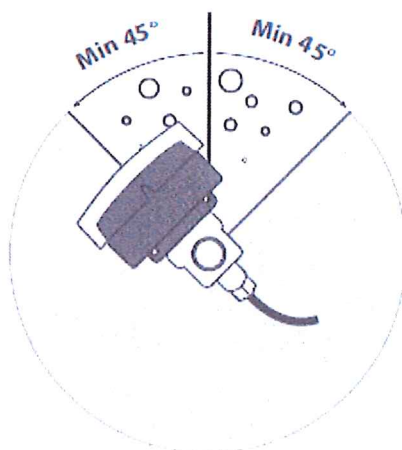

Application seals

The Energy meter has three or four application seals.

- One at the Temperature Sensor/Flow Sensor.
- One at the Temperature Sensor/Pipe.
- One or two at the Calculator enclosure.

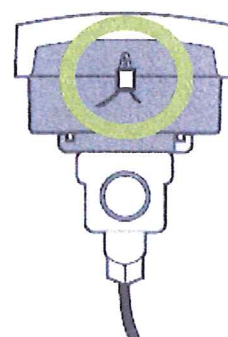
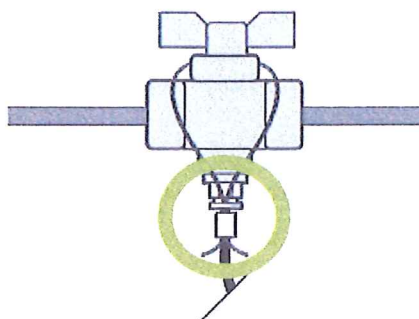
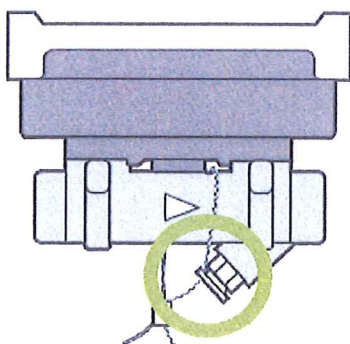

Factory seals

The factory seals (3) are not to be broken.

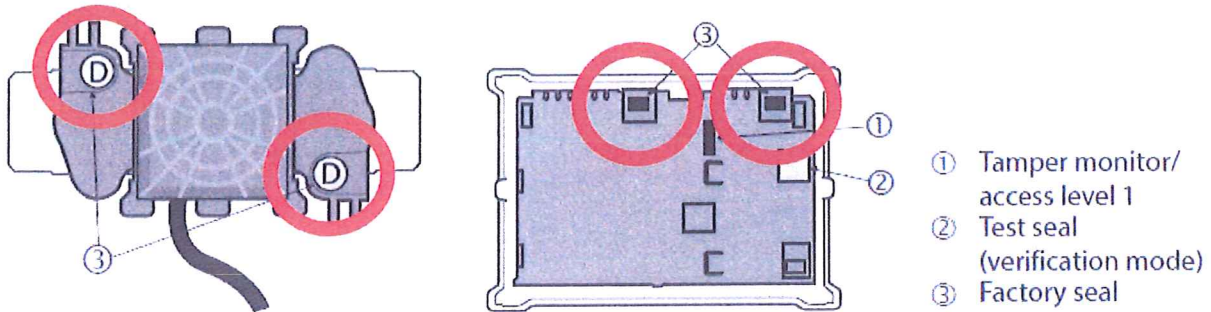

To set the Energy meter in verification mode, the Calculator application seal must be broken and the enclosure opened.

When the enclosure is opened, the Tamper monitor (1) will be activated, and "SEtUP" will be shown in display until the button is pressed.

Error code E13 is shown to indicate enclosure is or has been opened (only for SonoSelect).

Service symbol  is shown to indicate operating condition.

Verification seal (test seal)

To set the Energy meter in verification mode, the verification seal (2) must be broken.

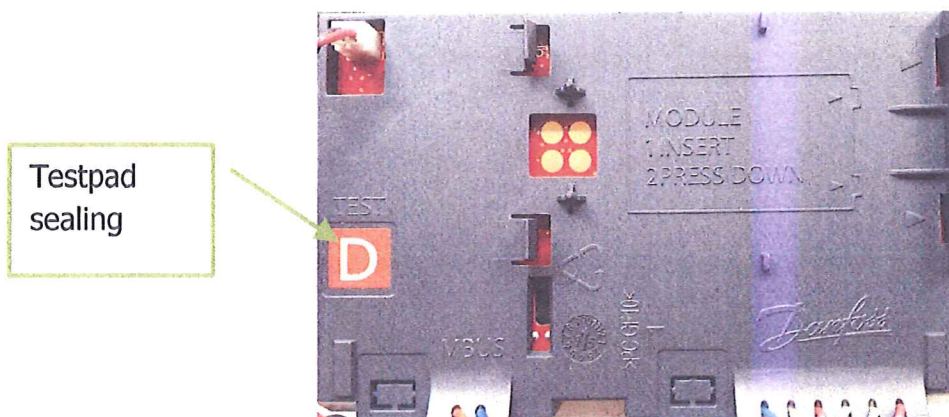
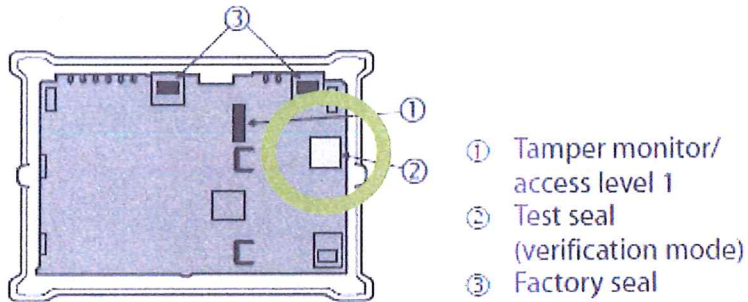

Contacts

To set the Energy meter in verification mode, the two contact pads must be short circuited for more than 1 second. Be careful not to scratch or damage the printed circuit board and contacts.

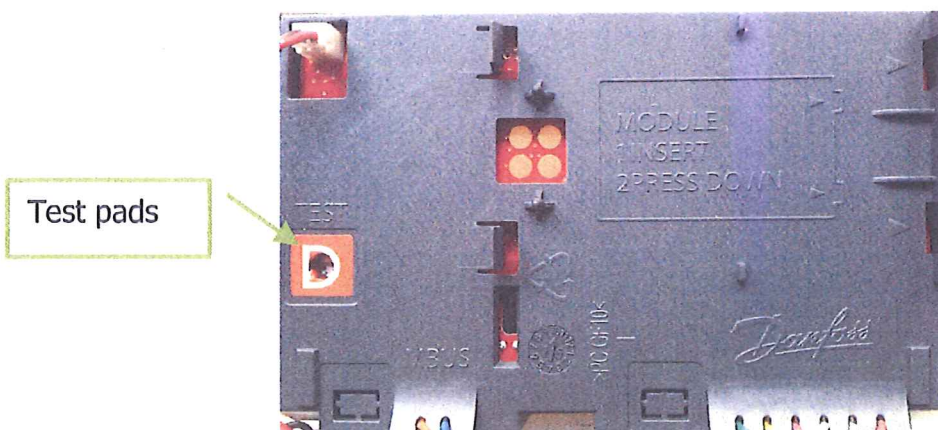

When the test pads are short circuited, "tEst" will be shown in display until the button is pressed.

Error code E13 is shown to indicate enclosure is or has been opened (only for SonoSelect).

Service symbol  is shown to indicate operating condition.

In verification mode, Energy and Volume is shown with a higher resolution in the display.

A temporary overflow in the display will not affect the stored Volume or Energy.

The Energy meter will stay in Verification Mode for at least 8 hours.

Communication during the last hour will extend the time to 1 hour.

If the Energy meter has returned to Normal Mode, a new short circuit will start a new 8-hour interval in Verification Mode.

Normal/Verification mode display format

The resolution in the display depends on Normal Mode or Verification Mode.

	Normal		Verification	
	Decimals	Format	Decimals	Format
Volume	2	000000.00 m ³	5	0000.00000 m ³
Energy	0	00000000 kWh	4	0000.0000 kWh
Energy	3 ^{*2}	00000.000 GJ	6	0000.000000 GJ
Energy	3	00000.000 GCal	6	0000.000000 GCal

² For qp 6.0 m³/h variants, only 2 decimals.

Accuracy

Flow meter:

$$E_f = \pm \left(2 + 0.02 \cdot \frac{q_p}{q} \right) \%, \text{ but maximum } \pm 5\%.$$

Calculator (incl. Energy calculation):

$$E_c = \pm \left(0.5 + \frac{\Delta\Theta_{\min}}{\Delta\Theta} \right) \%, \text{ where } \Delta\Theta_{\min} = 3\text{K}.$$

Temperature Sensors:

$$E_t = \pm \left(0.5 + 3 \cdot \frac{\Delta\Theta_{\min}}{\Delta\Theta} \right) \%, \text{ where } \Delta\Theta_{\min} = 3\text{K}.$$

Combined Temperature Sensors and Calculator (incl. Energy calculation):

$$E_{t+c} = \pm \left(1 + 4 \cdot \frac{\Delta\Theta_{\min}}{\Delta\Theta} \right) \%, \text{ where } \Delta\Theta_{\min} = 3\text{K}.$$

Complete meter:

Chart with Class 2 error vs. flow rate and with additional errors from difference temperature and Energy calculation.

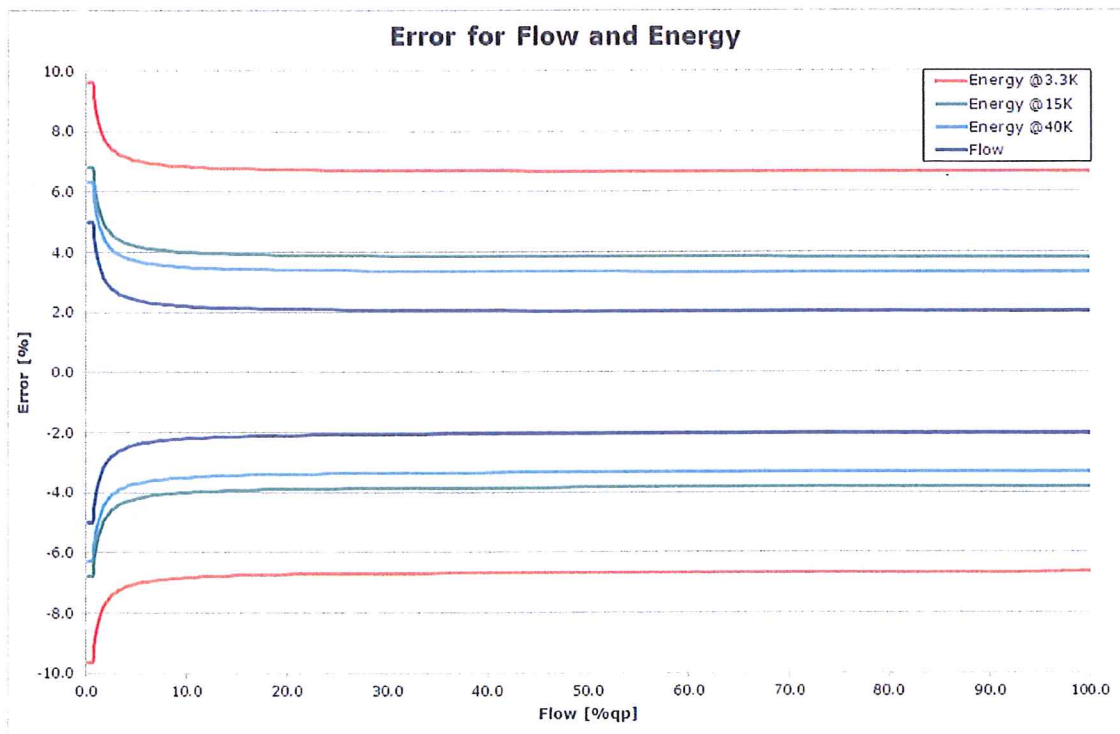

Flow measurement

A number of topics have an influence on measuring time:

- Expected measuring accuracy for the test.
- Flow rate.
- Display resolution.
- Flow noise or flow fluctuations.
- Volume on scale and scale resolution/accuracy.
- Reference meter resolution/accuracy.

Verification and Re-verification of the flow-part must be performed at $50 \pm 5^\circ\text{C}$.

Test points are:

- a) $q_i \leq q \leq 1.2 q_i$;
- b) $0.1 q_p \leq q \leq 0.11 q_p$;
- c) $0.9 q_p \leq q \leq 1.1 q_p$.

Minimum test times and volumes.

	qp = 0.60 m ³ /h			qp = 1.50 m ³ /h			qp = 2.50 m ³ /h		
Test point	a	b	c	a	b	c	a	b	c
Time [seconds]	3000	400	120	1200	400	120	800	400	120
Volume [litre]	5.00	6.67	20.00	5.00	16.67	50.00	5.56	27.78	83.33

	qp = 3.50 m ³ /h			qp = 6.00 m ³ /h		
Test point	a	b	c	a	b	c
Time [seconds]	800	400	120	800	400	120
Volume [litre]	7.78	38.89	116.67	13.33	66.67	200.0

If the resolution and the repeatability in the measurements are acceptable, the volume and measuring time can be reduced, but never less than 120 seconds.

Energy measurement with simulated flow

The Energy meter can be verified using simulated flow and measured temperatures.

The Temperature Sensors must be placed in two temperature regulated baths with known constant temperature.

The Reference energy can be calculated using the shown Heat coefficients and the expression:

$$Q_{\text{Supply}} = HC_{\text{Supply}} * \text{Volume} * \Delta\theta$$

or

$$Q_{\text{Return}} = HC_{\text{Return}} * \text{Volume} * \Delta\theta$$

where:

- Heat coefficient (HC) depends on Flow sensor installation and temperature difference;
- Volume is the simulated accumulated value (read from display in each test);
- Temperature difference ($\Delta\theta$) is the actual difference from temperature baths.

Flow simulation:

The simulated flow is kept at a constant flowrate of $0.75 * q_p$ during each test sequence.

The test sequence uses a constant time interval (120 seconds).

EN1434-5 §6.7 defines the outlet temperature to be $50^\circ\text{C} \pm 5^\circ\text{C}$.

To be able to test Energy meters for both Supply and Return installation, this demand is interpreted as "the temperature for the Flow Sensor must be $50^\circ\text{C} \pm 5^\circ\text{C}$ ".

Temperature:

$$45^\circ\text{C} \leq \theta_{\text{FlowSensor}} \leq 55^\circ\text{C}$$

a) $3.0\text{K} \leq \Delta\theta \leq 3.6\text{K}$

b) $10\text{K} \leq \Delta\theta \leq 20\text{K}$

c) $85\text{K} \leq \Delta\theta \leq 90\text{K}$ (standard 95°C variant)

c) $120\text{K} \leq \Delta\theta \leq 125\text{K}$ (130°C variant)

In order to comply with the product specifications:

- $\theta_{\text{max}} = 95^\circ\text{C}$, $\theta_{\text{min}} = 5^\circ\text{C}$ and $\Delta\theta_{\text{max}} = 90\text{K}$ (standard 95°C variant)
- $\theta_{\text{max}} = 130^\circ\text{C}$, $\theta_{\text{min}} = 5^\circ\text{C}$ and $\Delta\theta_{\text{max}} = 125\text{K}$ (130°C variant)

When changing bath or temperature in a bath, wait at least 1 minute for the measurements to stabilize (response time in the Temperature Sensor and filter constants).

Table with Heat coefficient overview for selected $\Delta\theta$ & θ .

Supply Heat coefficient overview						
Test point	a	b	c* 95°C	c* 95°C	c* 130°C	c* 130°C
Temperature Supply [°C]	50.0	50.0	50.0	92.5	127.5	127.5
Temperature Return [°C]	46.7	35.0	5.0	5.0	50.0	5.0
Temperature Difference [K]	3.3	15.0	45.0	87.5	77.5	122.5
HC Supply [MJ/m ³ /K]	4.12858	4.12802	4.13267	4.03413	3.94333	3.93448
HC Supply [kWh/m ³ /K]	1.14683	1.14667	1.14796	1.12059	1.09537	1.09291
HC Supply [GCal/m ³ /K]	0.00098609	0.00098596	0.00098707	0.00096353	0.00094185	0.00093973

Return Heat coefficient overview						
Test point	a	b	c* 95°C	c* 95°C	c* 130°C	c* 130°C
Temperature Supply [°C]	53.3	65.0	95.0	92.5	127.5	127.5
Temperature Return [°C]	50.0	50.0	50.0	5.0	50.0	5.0
Temperature Difference [K]	3.3	15.0	45.0	87.5	77.5	122.5
HC Return [MJ/m ³ /K]	4.12932	4.13136	4.14087	4.18637	4.15809	4.19912
HC Return [kWh/m ³ /K]	1.14703	1.14760	1.15024	1.16288	1.15503	1.16642
HC Return [GCal/m ³ /K]	0.00098627	0.00098676	0.00098903	0.00099990	0.00099314	0.00100294

Note:

c* 95°C: standard 95°C variant

c* 130°C: 130°C variant

Example

Tables with nominal values for volume, temperatures, heat coefficients and energy (Supply).

Energy Supply overview						
qp = 0.60 m ³ /h						
Test point	a	b	c* 95°C	c* 95°C	c* 130°C	c* 130°C
Temperature Supply [°C]	50.0	50.0	50.0	92.5	127.5	127.5
Temperature Return [°C]	46.7	35.0	5.0	5.0	50.0	5.0
Temperature Difference [K]	3.3	15.0	45.0	87.5	77.5	122.5
HC Supply [MJ]/m ³ /K]	4.1286	4.1280	4.1327	4.0341	3.9433	3.9345
qp [m ³ /h]	0.600	0.600	0.600	0.600	0.600	0.600
Flow [%]	75.0	75.0	75.0	75.0	75.0	75.0
Flow [m ³ /h]	0.450	0.450	0.450	0.450	0.450	0.450
Time [seconds]	120	120	120	120	120	120
Volume [m ³]	0.01500	0.01500	0.01500	0.01500	0.01500	0.01500
Energy [MJ]	0.20436	0.92881	2.78955	5.29479	4.58412	7.22960
Energy [kWh]	0.05677	0.25800	0.77488	1.47077	1.27337	2.00822
Energy [GCal]	4.881E-5	2.218E-4	6.663E-4	1.265E-3	1.095E-3	1.727E-3
Allowed Energy error [%] (Incl. Temperature Sensors)	±4.64	±1.80	±1.27	±1.14	±1.15	±1.10

Energy Supply overview						
qp = 1.50 m ³ /h						
Test point	a	b	c* 95°C	c* 95°C	c* 130°C	c* 130°C
Temperature Supply [°C]	50.0	50.0	50.0	92.5	127.5	127.5
Temperature Return [°C]	46.7	35.0	5.0	5.0	50.0	5.0
Temperature Difference [K]	3.3	15.0	45.0	87.5	77.5	122.5
HC Supply [MJ]/m ³ /K]	4.1286	4.1280	4.1327	4.0341	3.9433	3.9345
qp [m ³ /h]	1.500	1.500	1.500	1.500	1.500	1.500
Flow [%]	75.0	75.0	75.0	75.0	75.0	75.0
Flow [m ³ /h]	1.125	1.125	1.125	1.125	1.125	1.125
Time [seconds]	120	120	120	120	120	120
Volume [m ³]	0.03750	0.03750	0.03750	0.03750	0.03750	0.03750
Energy [MJ]	0.51091	2.32201	6.97388	13.23697	11.46030	18.07400
Energy [kWh]	0.14192	0.64500	1.93719	3.67694	3.18342	5.02055
Energy [GCal]	1.220E-4	5.546E-4	1.666E-3	3.162E-3	2.737E-3	4.317E-3
Allowed Energy error [%] (Incl. Temperature Sensors)	±4.64	±1.80	±1.27	±1.14	±1.15	±1.10

Energy Supply overview						
qp = 2.50 m ³ /h						
Test point	a	b	c* 95°C	c* 95°C	c* 130°C	c* 130°C
Temperature Supply [°C]	50.0	50.0	50.0	92.5	127.5	127.5
Temperature Return [°C]	46.7	35.0	5.0	5.0	50.0	5.0
Temperature Difference [K]	3.3	15.0	45.0	87.5	77.5	122.5
HC Supply [MJ]/m ³ /K]	4.1286	4.1280	4.1327	4.0341	3.9433	3.9345
qp [m ³ /h]	2.500	2.500	2.500	2.500	2.500	2.500
Flow [%]	75.0	75.0	75.0	75.0	75.0	75.0
Flow [m ³ /h]	1.875	1.875	1.875	1.875	1.875	1.875
Time [seconds]	120	120	120	120	120	120
Volume [m ³]	0.06250	0.06250	0.06250	0.06250	0.06250	0.06250
Energy [MJ]	0.85152	3.87002	11.62314	22.06162	19.10051	30.12333
Energy [kWh]	0.23653	1.07501	3.22865	6.12823	5.30570	8.36759
Energy [GCal]	2.034E-4	9.243E-4	2.776E-3	5.269E-3	4.562E-3	7.195E-3
Allowed Energy error [%] (Incl. Temperature Sensors)	±4.64	±1.80	±1.27	±1.14	±1.15	±1.10

DK-0200-MI004-034

Tables with nominal values for volume, temperatures, heat coefficients and energy (Supply continued).

Energy Supply overview						
qp = 3.50 m ³ /h						
Test point	a	b	c* 95°C	c* 95°C	c* 130°C	c* 130°C
Temperature Supply [°C]	50.0	50.0	50.0	92.5	127.5	127.5
Temperature Return [°C]	46.7	35.0	5.0	5.0	50.0	5.0
Temperature Difference [K]	3.3	15.0	45.0	87.5	77.5	122.5
HC Supply [MJ/m ³ /K]	4.1286	4.1280	4.1327	4.0341	3.9433	3.9345
qp [m ³ /h]	3.500	3.500	3.500	3.500	3.500	3.500
Flow [%]	75.0	75.0	75.0	75.0	75.0	75.0
Flow [m ³ /h]	2.625	2.625	2.625	2.625	2.625	2.625
Time [seconds]	120	120	120	120	120	120
Volume [m ³]	0.08750	0.08750	0.08750	0.08750	0.08750	0.08750
Energy [MJ]	1.19213	5.41803	16.27239	30.88627	26.74071	42.17266
Energy [kWh]	0.33115	1.50501	4.52011	8.57952	7.42797	11.71463
Energy [GCal]	2.847E-4	1.294E-3	3.887E-3	7.377E-3	6.387E-3	1.007E-2
Allowed Energy error [%] (Incl. Temperature Sensors)	±4.64	±1.80	±1.27	±1.14	±1.15	±1.10

Energy Supply overview						
qp = 6.00 m ³ /h						
Test point	a	b	c* 95°C	c* 95°C	c* 130°C	c* 130°C
Temperature Supply [°C]	50.0	50.0	50.0	92.5	127.5	127.5
Temperature Return [°C]	46.7	35.0	5.0	5.0	50.0	5.0
Temperature Difference [K]	3.3	15.0	45.0	87.5	77.5	122.5
HC Supply [MJ/m ³ /K]	4.1286	4.1280	4.1327	4.0341	3.9433	3.9345
qp [m ³ /h]	6.000	6.000	6.000	6.000	6.000	6.000
Flow [%]	75.0	75.0	75.0	75.0	75.0	75.0
Flow [m ³ /h]	4.500	4.500	4.500	4.500	4.500	4.500
Time [seconds]	120	120	120	120	120	120
Volume [m ³]	0.15000	0.15000	0.15000	0.15000	0.15000	0.15000
Energy [MJ]	2.04365	9.28806	27.89553	52.94789	45.84122	72.29598
Energy [kWh]	0.56768	2.58002	7.74876	14.70775	12.73367	20.08222
Energy [GCal]	4.881E-4	2.218E-3	6.663E-3	1.265E-2	1.095E-2	1.727E-2
Allowed Energy error [%] (Incl. Temperature Sensors)	±4.64	±1.80	±1.27	±1.14	±1.15	±1.10

Note:

c* 95°C: standard 95°C variant

c* 130°C: 130°C variant

Tables with nominal values for volume, temperatures, heat coefficients and energy (Return).

Energy Return overview						
qp = 0.60 m ³ /h						
Test point	a	b	c* 95°C	c* 95°C	c* 130°C	c* 130°C
Temperature Supply [°C]	53.3	65.0	95.0	92.5	127.5	127.5
Temperature Return [°C]	50.0	50.0	50.0	5.0	50.0	5.0
Temperature Difference [K]	3.3	15.0	45.0	87.5	77.5	122.5
HC Return [MJ/m ³ /K]	4.1293	4.1314	4.1409	4.1864	4.1581	4.1991
qp [m ³ /h]	0.600	0.600	0.600	0.600	0.600	0.600
Flow [%]	75.0	75.0	75.0	75.0	75.0	75.0
Flow [m ³ /h]	0.450	0.450	0.450	0.450	0.450	0.450
Time [seconds]	120	120	120	120	120	120
Volume [m ³]	0.01500	0.01500	0.01500	0.01500	0.01500	0.01500
Energy [MJ]	0.20440	0.92956	2.79509	5.49461	4.83378	7.71589
Energy [kWh]	0.05678	0.25821	0.77641	1.52628	1.34272	2.14330
Energy [GCal]	4.882E-5	2.220E-4	6.676E-4	1.312E-3	1.155E-3	1.843E-3
Allowed Energy error [%] (Incl. Temperature Sensors)	±4.64	±1.80	±1.27	±1.14	±1.15	±1.10

Energy Return overview						
qp = 1.50 m ³ /h						
Test point	a	b	c* 95°C	c* 95°C	c* 130°C	c* 130°C
Temperature Supply [°C]	53.3	65.0	95.0	92.5	127.5	127.5
Temperature Return [°C]	50.0	50.0	50.0	5.0	50.0	5.0
Temperature Difference [K]	3.3	15.0	45.0	87.5	77.5	122.5
HC Return [MJ/m ³ /K]	4.1293	4.1314	4.1409	4.1864	4.1581	4.1991
qp [m ³ /h]	1.500	1.500	1.500	1.500	1.500	1.500
Flow [%]	75.0	75.0	75.0	75.0	75.0	75.0
Flow [m ³ /h]	1.125	1.125	1.125	1.125	1.125	1.125
Time [seconds]	120	120	120	120	120	120
Volume [m ³]	0.03750	0.03750	0.03750	0.03750	0.03750	0.03750
Energy [MJ]	0.51100	2.32389	6.98772	13.73654	12.08445	19.28972
Energy [kWh]	0.14195	0.64553	1.94103	3.81570	3.35679	5.35825
Energy [GCal]	1.221E-4	5.551E-4	1.669E-3	3.281E-3	2.886E-3	4.607E-3
Allowed Energy error [%] (Incl. Temperature Sensors)	±4.64	±1.80	±1.27	±1.14	±1.15	±1.10

Energy Return overview						
qp = 2.50 m ³ /h						
Test point	a	b	c* 95°C	c* 95°C	c* 130°C	c* 130°C
Temperature Supply [°C]	53.3	65.0	95.0	92.5	127.5	127.5
Temperature Return [°C]	50.0	50.0	50.0	5.0	50.0	5.0
Temperature Difference [K]	3.3	15.0	45.0	87.5	77.5	122.5
HC Return [MJ/m ³ /K]	4.1293	4.1314	4.1409	4.1864	4.1581	4.1991
qp [m ³ /h]	2.500	2.500	2.500	2.500	2.500	2.500
Flow [%]	75.0	75.0	75.0	75.0	75.0	75.0
Flow [m ³ /h]	1.875	1.875	1.875	1.875	1.875	1.875
Time [seconds]	120	120	120	120	120	120
Volume [m ³]	0.06250	0.06250	0.06250	0.06250	0.06250	0.06250
Energy [MJ]	0.85167	3.87315	11.64619	22.89423	20.14075	32.14953
Energy [kWh]	0.23658	1.07588	3.23505	6.35951	5.59465	8.93042
Energy [GCal]	2.034E-4	9.251E-4	2.782E-3	5.468E-3	4.811E-3	7.679E-3
Allowed Energy error [%] (Incl. Temperature Sensors)	±4.64	±1.80	±1.27	±1.14	±1.15	±1.10

DK-0200-MI004-034

Tables with nominal values for volume, temperatures, heat coefficients and energy (Return continued).

Energy Return overview						
	qp = 3.50 m ³ /h					
Test point	a	b	c* 95°C	c* 95°C	c* 130°C	c* 130°C
Temperature Supply [°C]	53.3	65.0	95.0	92.5	127.5	127.5
Temperature Return [°C]	50.0	50.0	50.0	5.0	50.0	5.0
Temperature Difference [K]	3.3	15.0	45.0	87.5	77.5	122.5
HC Return [MJ/m ³ /K]	4.1293	4.1314	4.1409	4.1864	4.1581	4.1991
qp [m ³ /h]	3.500	3.500	3.500	3.500	3.500	3.500
Flow [%]	75.0	75.0	75.0	75.0	75.0	75.0
Flow [m ³ /h]	2.625	2.625	2.625	2.625	2.625	2.625
Time [seconds]	120	120	120	120	120	120
Volume [m ³]	0.08750	0.08750	0.08750	0.08750	0.08750	0.08750
Energy [MJ]	1.19234	5.42241	16.30467	32.05192	28.19705	45.00934
Energy [kWh]	0.33121	1.50623	4.52908	8.90331	7.83251	12.50259
Energy [GCal]	2.848E-4	1.295E-3	3.894E-3	7.655E-3	6.735E-3	1.075E-2
Allowed Energy error [%] (Incl. Temperature Sensors)	±4.64	±1.80	±1.27	±1.14	±1.15	±1.10

Energy Return overview						
	qp = 6.00 m ³ /h					
Test point	a	b	c* 95°C	c* 95°C	c* 130°C	c* 130°C
Temperature Supply [°C]	53.3	65.0	95.0	92.5	127.5	127.5
Temperature Return [°C]	50.0	50.0	50.0	5.0	50.0	5.0
Temperature Difference [K]	3.3	15.0	45.0	87.5	77.5	122.5
HC Return [MJ/m ³ /K]	4.1293	4.1314	4.1409	4.1864	4.1581	4.1991
qp [m ³ /h]	6.000	6.000	6.000	6.000	6.000	6.000
Flow [%]	75.0	75.0	75.0	75.0	75.0	75.0
Flow [m ³ /h]	4.500	4.500	4.500	4.500	4.500	4.500
Time [seconds]	120	120	120	120	120	120
Volume [m ³]	0.15000	0.15000	0.15000	0.15000	0.15000	0.15000
Energy [MJ]	2.04401	9.29556	27.95086	54.94615	48.33780	77.15887
Energy [kWh]	0.56778	2.58210	7.76413	15.26282	13.42717	21.43302
Energy [GCal]	4.882E-4	2.220E-3	6.676E-3	1.312E-2	1.155E-2	1.843E-2
Allowed Energy error [%] (Incl. Temperature Sensors)	±4.64	±1.80	±1.27	±1.14	±1.15	±1.10

Note:

c* 95°C: standard 95°C variant

c* 130°C: 130°C variant

Selecting simulated flow

The Energy meter must be in Verification mode, see page 10.
 Energy and Volume is shown with normal units, but with more decimals (no frame on decimals).
 After 8 hours the Energy meter automatically returns to Normal mode.
 When in Verification mode, Flow simulation mode can be accessed with a long button press.

Flow simulation mode use special totalizers during the test sequence.

These Volume and Energy totalizers are set to zero when Flow simulation mode is activated (started).

After a defined time (e.g. 120 seconds) accumulation is stopped.

Simulation mode, Volume and Energy is shown in the display with a short button press.

Menu/Mode selection:

- A short button press (<2s) will change menu within a Loop.
- A button press (>2s and <5s) will change from menu Loop1 to Loop2 or back.
- A long button press (>5s) will change to a special energy test menu.
- A button press (>2s) will change back to normal menu (Loop1).

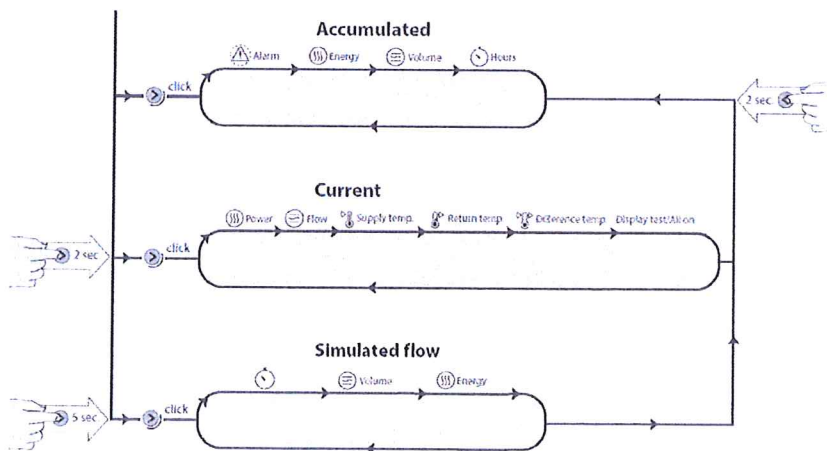

Flow simulation mode started and counting:

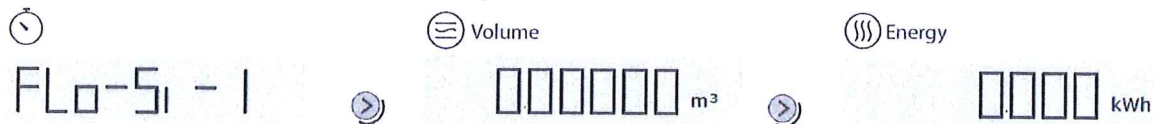

Flow simulation mode stopped:



DK-0200-MI004-034

For each test (a, b & c) the measured Energy value must be compared to calculated Reference Energy using simulated Volume and Temperature Difference.
Permissible Energy error (incl. Temperature Sensors), see page 12.

Parameters

A few settings (parameters) can be changed when the Energy meter is in verification mode. (Access Level is set to Re-verification).

To change any settings, an Optical dongle and the Danfoss App. Tool for Smartphones are needed.

The communication protocol is EN13757 and CJ/T-188 compliant.

Changeable Parameters:

- Customer information
- AccumulatedEnergy unit
- AccumulatedEnergy decimals
- CorrectionFactor
- AccumulatedVolume
- AccumulatedEnergy
- VolumePulseInAmount_I
- VolumePulseInAmount_II
- AccumulatedVolumePulse_I
- AccumulatedVolumePulse_II

Physical Output

SonoSelect and SonoSafe have no physical pulse output for testing purposes.

Finishing

When the test is finished and the results are approved, an appropriate adhesive seal must be placed to cover/protect the test pads.

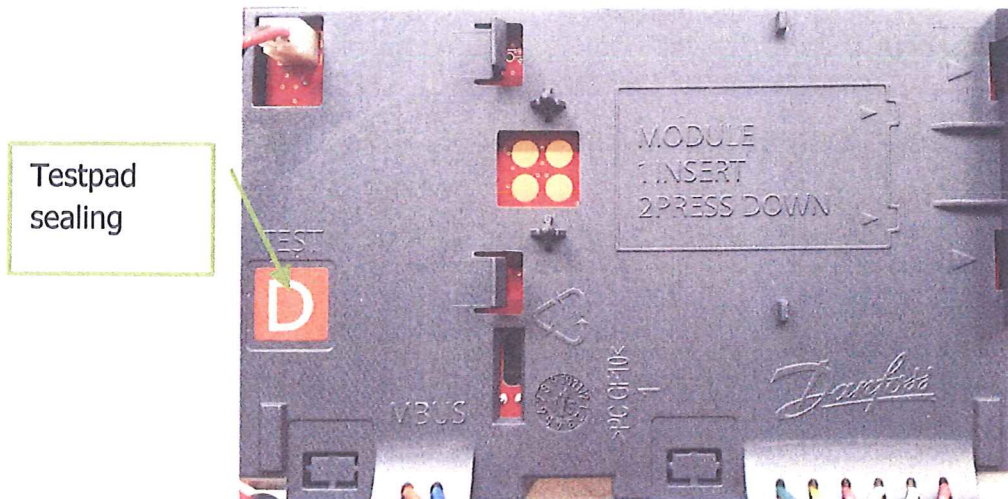

Close the Calculator securing that no wires are jammed by enclosure parts and rubber sealing.

Reset AccumulatedVolume, AccumulatedEnergy, AccumulatedVolumePulse_I and AccumulatedVolumePulse_II if needed.

The Energy meter will return to Normal Mode after 8 hours, or can be set to Normal Mode using the App. Tool.

Remove Tamper alarm E13 using App. Tool (only for SonoSelect).

If a Temperature Sensor is removed from Flow Sensor during verification, the correct one must be re-assembled to secure correct function.

Mount the Temperature Sensor in the Flow Sensor according to the symbol in the display.

 Supply.
Temperature Sensor with **red** label marking in Flow Sensor.

 Return.
Temperature Sensor with **blue** label marking in Flow Sensor.

See annex

Mount application wire sealing on Calculator and Temperature Sensors if needed.

Security measures
Meter sealing

Application
 sealing

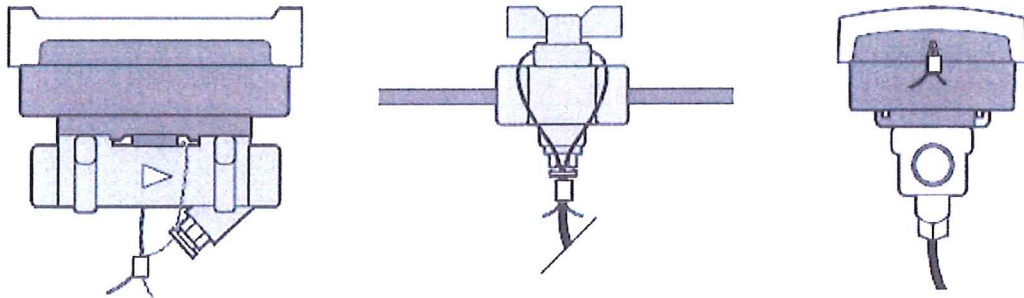

Factory and
 verification
 sealing

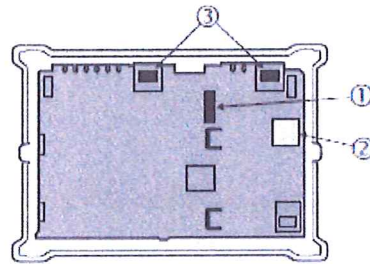
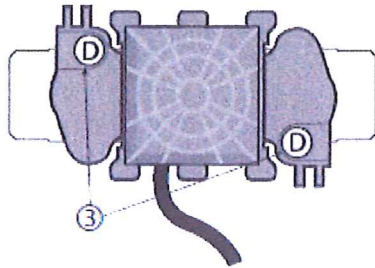

- ① Tamper monitor/
access level 1
- ② Test seal
(verification mode)
- ③ Factory seal

Marking and inscriptions

Front cover (laser engraved)

Type identification, serial number and code number
Manufacturer's logo and year of manufacturing
CE marking and supplementary metrology marking
EC-Type Examination Certificate number
Firmware version
Electromagnetic / mechanical environment classes and IP class
Accuracy class
Limits of flow rate (q_i , q_p and q_s)
Limits of temperature (θ_{\min} - θ_{\max}) and differential temperature ($\Delta\theta_{\min}$ - $\Delta\theta_{\max}$)
Temperature sensor type
Pressure stage
Connection and length
Secondary communication address

Back cover (label)

Manufacturer's address and production site

Flow sensor body

Arrow indicating direction of flow

Additional information in the display

Unit of measurement
Supply or Return pipe installation

Examples

Inscriptions on SonoSelect 10 front cover

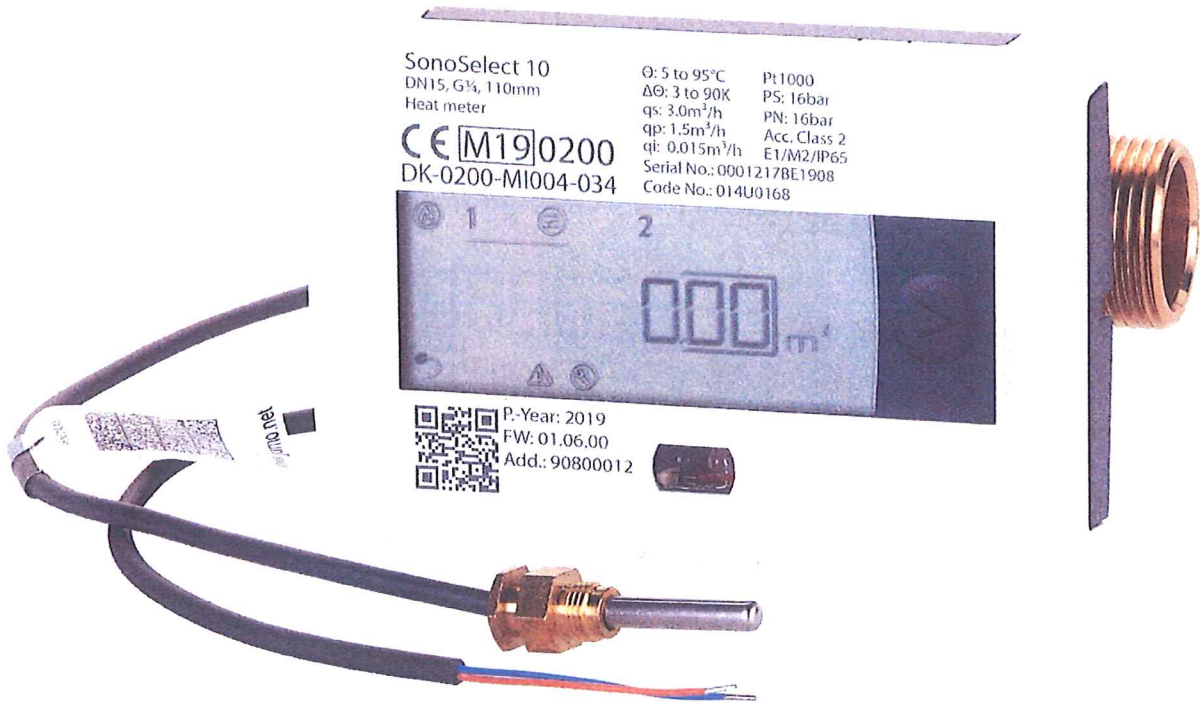

Label on back cover



Informative Annex

Integrated functions not subject to the Measuring Instruments Directive:

Integrated Cooling function

The SonoSafe 10 and SonoSelect 10 are type tested as Heating and Cooling energy meter according to EN 1434-4:2015 + A1:2018.

The integrated Cooling function can therefore be utilized under the operating conditions as described in this certificate.

If a Temperature Sensor is removed from Flow Sensor during verification, the correct one must be re-assembled to secure correct function.

Mount the Temperature Sensor in the Flow Sensor according to the symbol in the display.

-  Supply.
Temperature Sensor with **blue** label marking in Flow Sensor.
-  Return.
Temperature Sensor with **red** label marking in Flow Sensor.



Bifunctional function

The SonoSafe 10 and SonoSelect 10 are type tested as Heating, Cooling and Bifunctional energy meter according to EN 1434-4:2015 + A1:2018.

The Bifunctional Heating or Cooling function can therefore be utilized under the operating conditions as described in this certificate.

If a Temperature Sensor is removed from Flow Sensor during verification, the correct one must be re-assembled to secure correct function.

Mount the Temperature Sensor in the Flow Sensor according to the symbol in the display.

-  Supply.
Temperature Sensor with **red** label marking in Flow Sensor.
-  Return.
Temperature Sensor with **blue** label marking in Flow Sensor.