

Technical Information

PLUS+1 Mobile Machine Displays

DP6XX™ Series



Revision history

Table of revisions

Date	Changed	Rev
November 2017	Minor correction	0105
November 2016	Updated for Engineering Tomorrow	0104
June 2015	AWG corrected regarding crimp tool and connector; and corrected product accessory name to: Panel mounting spring clip	AC
November 2014	Minor update	AB
August 2014	First edition	AA

Contents

Literature references

DP6XXTM reference literature.....	4
Technical Information (TI).....	4
Data Sheet (DS).....	4
PLUS+1 [®] GUIDE User Manual.....	4
Latest version of technical literature.....	4

User liability and safety statements

OEM responsibility.....	5
-------------------------	---

Overview

DP6XXTM Series Displays.....	6
PLUS+1 [®] GUIDE.....	6
Linux [®] operating system.....	6
Features for the Linux [®] interface.....	6

Ordering information

Product naming convention.....	7
Related products.....	8
Assembled mating connector kits.....	8
Accessories.....	9

Inputs/outputs

Inputs.....	10
Digital/analog.....	10
Multifunction.....	11
Encoder.....	12
Outputs.....	13
Video.....	13
USB.....	13

Controller Area Network (CAN) specifications

CAN shield/analog inputs.....	15
CAN communication.....	15
Gateway channels.....	15

Memory

NV memory.....	17
FRAM Memory.....	17
Vault Memory.....	17

Product ratings

Electrical.....	18
Environmental.....	18
Testing criteria.....	18

Maintenance guidelines

LCD module	20
------------------	----

Installation

Dimensions.....	21
Two mounting options.....	22
Flush mounted.....	22
Stand-alone on post.....	23
Pin assignments.....	24
Machine wiring guidelines.....	25
Machine welding guidelines.....	25

Literature references

DP6XXTM reference literature

Literature title	Literature type	Literature number
<i>DP6XXTM Series PLUS+1® Mobile Machine Displays</i>	Technical Information	L1418812
<i>DP600TM Series PLUS+1® Mobile Machine Displays</i>	Data Sheet	L1428438
<i>DP610TM Series PLUS+1® Mobile Machine Displays</i>	Data Sheet	L1428501
<i>PLUS+1® GUIDE Software User Manual</i>	Operation Manual	10100824

Technical Information (TI)

A TI is comprehensive information for engineering and service personnel to reference.

Data Sheet (DS)

A DS is summarized information and parameters that are unique to a specific model.

PLUS+1® GUIDE User Manual

This user operation manual (OM) details information regarding the PLUS+1® GUIDE tool set that is used to build PLUS+1® applications. This OM covers the following broad topics:

- How to use the PLUS+1® GUIDE graphical application development tool to create machine applications
- How to configure module input and output parameters
- How to download PLUS+1® GUIDE applications to target PLUS+1® hardware modules
- How to upload and download tuning parameters
- How to use the PLUS+1® Service Tool

Latest version of technical literature

Danfoss product literature is online at: <http://powersolutions.danfoss.com/literature/>

User liability and safety statements

OEM responsibility

The OEM of a machine or vehicle in which Danfoss products are installed has the full responsibility for all consequences that might occur. Danfoss has no responsibility for any consequences, direct or indirect, caused by failures or malfunctions.

- Danfoss has no responsibility for any accidents caused by incorrectly mounted or maintained equipment.
- Danfoss does not assume any responsibility for Danfoss products being incorrectly applied or the system being programmed in a manner that jeopardizes safety.
- All safety critical systems shall include an emergency stop to switch off the main supply voltage for the outputs of the electronic control system. All safety critical components shall be installed in such a way that the main supply voltage can be switched off at any time. The emergency stop must be easily accessible to the operator.

Overview

PLUS+1[®] Mobile Machine Displays are designed to provide flexible, expandable, powerful and cost effective total machine management system displays for a wide variety of vehicle applications.

DP6XXTM Series Displays

DP6XXTM Series Displays are designed to perform in the most extreme mobile machine environments. The latest technology with backlight provides outstanding brightness and contrast performance resulting in an easy-to-read screen. Develop your own software and layout using the PLUS+1[®] GUIDE (Graphical User Integrated Development Environment) and the GUIDE Vector Based Screen Editor (VBSE). A basic graphic library is available.

PLUS+1[®] GUIDE

PLUS+1[®] GUIDE (Graphical User Integrated Development Environment) is a complete toolbox that generates downloadable applications for all programmable PLUS+1[®] Compliant products.

A screen editor allows easy development of applications by programmers without formal software development training. The expertise from a software engineer is not needed to find your way around in PLUS+1[®] GUIDE

Linux[®] operating system

DP6XXTM Series Displays contain embedded Linux[®] operating system software that is copyrighted software licensed under the GPL Version 2.0 or LGPL Version 2.1.

Linux[®] operating system software is free software; you can redistribute it and/or modify it under the terms of the GNU General Public License as published by the Free Software Foundation; Licenses full notice available:

GPL Version 2.0 <http://www.gnu.org/licenses/old-licenses/gpl-2.0.html>

LGPL Version 2.1 <http://www.gnu.org/licenses/old-licenses/lgpl-2.1.html>

As an installer of Linux[®] operating system you will have your own obligations under the licensing agreements, which may include among other things the obligation to include a copy of these licenses or to include an offer of a physical copy of the source code for such software with your distributions of the equipment. You should carefully review the licenses to determine what your obligations and options may be for your intended use.

Anyone in receipt of this program may obtain the complete corresponding source code from Danfoss for a period of three years after the last shipment of this product and/or spare parts by going on line at <http://www.danfoss.com> or include "source code for DP6XXTM" in your written request to:

PLUS+1[®] Helpdesk Danfoss (US) Company, 3500 Annapolis Lane North Plymouth, MN 55447 USA

Features for the Linux[®] interface

DP6XXTM Series Displays hardware contain the following features for the Linux[®] interface:

- The 1st stage of U-Boot boot loader is installed on the system.
- There is a recovery system for reprogramming the DP6XXTM operating system utilizing the PLUS+1[®] Service Tool.
- Linux[®] kernel v2.6 with drivers for all standard peripherals.
- To give the developer the possibility to connect to Linux[®] shell it is enabled by default.

Ordering information

Product naming convention

DP6XXTM model code

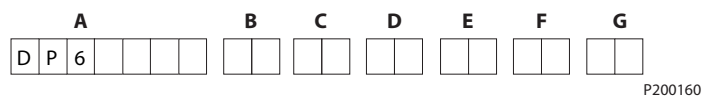

[This is not a variant configurator.](#)

Product configuration model code

A	B	C	D	E	F	G	Part number
DP600TM	09	02	06	02	04	05	11153505
DP600TM	09	02	06	02	04	06	11153512
DP610TM	10	02	06	02	04	05	11153502
DP610TM	10	02	06	02	04	06	11153515

A—Model name

Code	Description
DP600TM	PLUS+1® Mobile Machine Displays
DP610TM	

B—Input/output options

Code	Description
09	2 CAN, 2 DIN/AIN/FreqIn/Rheo/4-20 mA IN, 2 VideoIn
10	2 CAN, 2 DIN/AIN/FreqIn/Rheo/4-20 mA IN, 2 AIN/CAN Shield

C—Real time clock/low temperature functionality

Code	Description
02	RTC

D—Flash memory/application key

Code	Description
06	512 MB/without application key

E—Application log (vault memory)

Code	Description
02	16 MB

F—USB port type

Code	Description
04	USB device, host/RS232 in rear

Ordering information

G—Screen size/feature

Code	Description
05	400 x 240 color transmissive
06	400 x 240 color transmissive with anti-fog coating

Related products

Assembled mating connector kits

Danfoss mating connector kit and contents

Description	Part numbers	
Mating connector kit	11109743	
Connectors	Binder 5-pin male (USB cable included)	10100728
	Binder 8-pin male (USB cable included)	11109742
	DEUTSCH DTM06-6S 6-pin	10103494
	DEUTSCH DTM06-12SA 12-pin (16 to 22 AWG)	10102025
	DEUTSCH DTM06-12SA 12-pin (20 AWG)	10100944
Terminal	Binder and DEUTSCH	10100743
Crimp tool	16 to 22 AWG	10100744
	20 AWG	10100745
Locking plug	6-pin DEUTSCH WM 6S	10100742
	12-pin DEUTSCH WM 12S	10100741
IP 67 Seal Kit	DEUTSCH	10103495
	Binder	10103496

DEUTSCH mating connector kits and contents

Description	Part numbers	
6-pin connector kit	10103494	
DTM06-6S 6-pin connector	10100739	
12-pin connector kit (16 to 20 AWG)	10102025	
DTM06-12SA 12-pin connector	10100738	
12-pin connector kit (20 to 24 AWG)	10100944	
DTM06-12SA 12-pin connector	10100738	
Terminal Deutsch/Binder	10100743	
Crimp tool	16 to 22 AWG	10100744
	20 AWG	10100745
Locking plug	6-pin DEUTSCH WM 6S	10100742
	12-pin DEUTSCH WM 12S	10100741
IP 67 seal kit	DEUTSCH	10103495

Ordering information

Accessories

Description	Part number
Panel mounting spring clip	10101363
USB cable (device only)	10103497
USB cable (device and host)	11109121
PLUS+1® GUIDE Professional Software (Includes 1 year of software updates, a single user license, Service and Diagnostic Tool and Screen Editor)	11179523 (annual renewal with 11179524 to keep the software updates)

Inputs/outputs

Inputs

This series of displays support the following pin types:

- Digital or Analog (DIN/AIN)
- Multifunction (DIN/AIN/FreqIN, Rheo, 4–20 mA)
- Analog or Temperature or Rheostat (AIN/Temp/Rheo)
- Fixed Range Analog or CAN shield (AIN/CAN shield)

This series of displays have input pins that support multiple functions. Pins that support multiple input types are user-configurable using PLUS+1® GUIDE software.

Digital/analog

Low range multifunction input

Description	Unit	Minimum	Maximum	Comment
Range	mV	0	>350	—
Resolution	mV	0.15		1 mV in software
Worst case error	mV	$\pm(0.15 + U*5/2\%)$		—
Input impedance	k Ω	230 \pm 5		To 0 V
Input impedance with pull-down	k Ω	15 \pm 2		To 0 V
Input impedance with pull-up	k Ω	15 \pm 2		To 5 V
Input impedance with pull-up/down	k Ω	7.5 \pm 1		To 2.5 V

Normal range multifunction input

Description	Unit	Minimum	Maximum	Comment
Range	mV	0	>5.5	—
Resolution	mV	2		—
Worst case error	mV	$\pm(20 + U*2\%)$		—
Input impedance	k Ω	230 \pm 5		To 0 V
Input impedance with pull-down	k Ω	15 \pm 2		To 0 V
Input impedance with pull-up	k Ω	15 \pm 2		To 5 V
Input impedance with pull-up/down	k Ω	7.5 \pm 1		To 2.5 V

High range multifunction input

Description	Unit	Minimum	Maximum	Comment
Range	mV	0	>60	—
Resolution	mV	30		—
Worst case error	mV	$\pm(300 + U*3.8\%)$		—
Input impedance	k Ω	105 \pm 5		To 0 V
Input impedance with pull-down	k Ω	15 \pm 2		To 0 V
Input impedance with pull-up	k Ω	15 \pm 2		To 5 V
Input impedance with pull-up/down	k Ω	7.5 \pm 1		To 2.5 V

Inputs/outputs

Multifunction

Frequency input low range (ppu)

Description	Unit	Minimum	Maximum	Comment
Range	Hz	0	10000	In steps of 1 Hz
Sensitivity	mVpp	1000	—	Sinus peak-to-peak
Low threshold voltage	mV	75	200	—
High threshold voltage	mV	150	350	—
Input impedance	kΩ	230 ± 5		To 0 V
Input impedance with pull-down	kΩ	15 ± 2		To 0 V
Input impedance with pull-up	kΩ	15 ± 2		To 5 V
Input impedance with pull-up/down	kΩ	7.5 ± 1		To 2.5 V

Frequency input normal range (ppu)

Description	Unit	Minimum	Maximum	Comment
Range	Hz	0	10000	In steps of 1 Hz
Range (phase and quad)	Hz	0	5000	When measuring phase or quadrature counts
Low threshold voltage	V	1.1	2.6	—
High threshold voltage	V	2.2	4.4	—
Input impedance	kΩ	230 ± 5		To 0 V
Input impedance with pull-down	kΩ	15 ± 2		To 0 V
Input impedance with pull-up	kΩ	15 ± 2		To 5 V
Input impedance with pull-up/down	kΩ	7.5 ± 1		To 2.5 V

Resistance input

Description	Unit	Minimum	Maximum	Comment
Range	Ω	0	10000	In steps of 1 Ω
Resolution		1		@ 0 Ω
		2		@ 1 kΩ
		42		@ 10 kΩ
Source current	mA	0	4	—

4–20 mA input

Description	Unit	Minimum	Maximum	Comment
Range	mA	0	50	—
Resolution	μA	22		—
Worst case error	mA	±(0.2 + I*3%)		—
Input impedance	Ω	100 ± 3		To 0 V
Shut-off current	mA	54		—

Inputs/outputs

Warning

This product does not have a Real Time Operating System (RTOS). Frequency inputs are managed by the operating system. Because of this you should avoid using these inputs for any type of Safety Critical closed loop control as the accuracy maybe affected by processor load. They should only be used for non-safety critical related functions.

High level digital input

Description	Unit	Minimum	Maximum	Typical	Comment
Voltage range	V	0	63	—	—
Input resistance	kΩ	—	—	105	No pull-up/down
				13	With pull-up to 5 V
				13	Pull-down to ground
				7	With pull-up and down to 5 V
Programmable low threshold voltage	V	0	63	—	—
Programmable high threshold voltage	V	0	63	—	—
Rise time	μs	—	—	20	—
Fall time	μs	—	—	20	—

High level analog input

Description	Unit	Minimum	Maximum	Typical	Comment
Voltage range	V	0	63	—	—
Input resistance	kΩ	—	—	105	No pull-up/down
				13	With pull-up to 5 V
				13	Pull-down to ground
				7	With pull-up/down to 5 V
Analog voltage error (± 300 mV + U _{in} x 3.4%)	mV	—	—	± 100	U _{in} = 0 V
				± 2760	U _{in} = 70 V
Bandwidth	kHz	—	—	7.1	—

Encoder

The encoder input is only suitable for user interface functions, such as, navigating in menus and adjusting values because there is no guarantee that all pulses are detected and the detected direction can be false. The rate of pulses should be kept at a few tens per second to minimize the loss of detected position changes.

The encoder function samples the A and B signals from the encoder and increments or decrements the counter according to the phase sequence. The counter is incremented/decremented on every low to high and high to low edge of the A signal. Some encoders with detents give a complete pulse between detents and the counter will be incremented/decremented by two for every detent. The counter is incremented when the A signal is the leading phase and decremented in the opposite case.

Inputs/outputs

Outputs

Digital output

Description	Unit	Minimum value	Maximum value	Comment
Output current range	A	0	1	
Short circuit current	A	—	2	
Short circuit current peak	A	—	8	
Current measurement	A	0	2	

Video

Video output

Description	Unit	Minimum	Maximum	Typical	Comment
Short circuit protection	V	0	70	—	—
12 V output voltage (9 V < Ubat < 70 V)	V	11.5	12.7	12	—
12 V output current	A	—	—	0.5	Vbus < 5.25 V
24 V output voltage (9 V < Ubat < 70 V)	V	23	26	24	—
24 V output current	A	—	0.5	—	—
External video inputs	—	—	—	—	Both NTSC and PAL support

To power the camera up, it is recommended to use the display as power supply. If using a different power supply, it should meet the specification of the camera in regards of the voltage type and range, the current and voltage amount it can supply to its load, stability of the output voltage and current under varying line and load conditions, operating/storage temperature ranges.

[The use of a different power supply for the camera can create “noise” on the signal line which will affect its functionality.](#)

USB

USB input/output

Description	Unit	Minimum	Maximum	Typical	Comment
2.0 full speed	Mbit/s	—	—	12	—
Vbus input voltage	V	—	—	> 4.4	—
Vbus input resistance	kΩ	—	—	70	Vbus < 5.25 V
Short circuit protection (No damage)	V	0	70	—	—
Vbus output voltage	V	4.75	5.25	—	—
Vbus output current	A	—	—	0.5	—
Vbus short current	A	—	1.1	—	—

This series of displays all have USB ports that support memory sticks and computer connection. The display functions as a device when connected to a computer for diagnosis purposes or software download. The display functions as a host when a standard USB memory stick is connected so log-data can be transferred.

Inputs/outputs

Other than supporting memory sticks and computer connection, this display series USB port does not support any other standard computer peripherals.

Controller Area Network (CAN) specifications

CAN shield/analog inputs

The CAN shield pin on the unit can be used as a non-configurable analog input.

The values in the following table assumes that software compensates for errors in the analog to digital (A/D) converter.

CAN shield

Description	Unit	Minimum	Maximum	Typical	Comment
Input impedance	—	—	—	0.68 μ F + 1 Ω	—

Analog input (5 V only)

Description	Unit	Minimum	Maximum	Comment
Allowed voltage at pin	V	0	36	—
Measuring range	V	0	5.75	—
Resolution	mV	1.4		—
Worst case error	mV	$\pm(20 + U*2\%)$		—
Input impedance	k Ω	233 \pm 3		—

CAN communication

CAN communication

Description	Unit	Minimum	Maximum	Typical	Comment
Available baud rates	kBd	50	1000	50	With 120 Ω termination
				100	
				125	
				250	
				500	
				1000	
Maximum input voltage range	V	0	70	—	—

Gateway channels

PLUS+1[®] Service Tool can be connected to the CAN bus by using the following gateway channels.

Gateway channels

Channel	Description
0	DP600 only
1	DP600 + CAN0
2	DP600 + CAN1
3	DP600 + CAN0+1
4	CAN0
5	CAN1
6	CAN0+1

Selecting channel zero will not increase CAN traffic because of the PLUS+1[®] Service Tool communication.

Controller Area Network (CAN) specifications

Another PLUS+1® Service Tool can be connected to the CAN bus by using the following gateway channels.

Simultaneous usage Gateway channels

Channel	Description
0	CAN[0] and CAN[1]
1 or 4	CAN[1]
2 or 5	CAN[0]
3 or 6	No CAN port

Memory

NV memory

 **Caution**

Non-volatile (NV) memory data loss is possible when the NV write cycle is not fully completed. When downloading a new application ensure data is not being written to NV memory.

FRAM Memory

DP6XXTM Series Displays use Ferroelectric Random Access Memory (FRAM). FRAM has a write endurance of over 100 trillion cycles, which is ideal for datalogging. 2kB is available for application.

Vault Memory

DP6XXTM Series Displays have 16 MB of flash vault memory (application logging memory). Application developers use this memory to log machine event data then use the PLUS+1[®] Service Tool to extract the logged data.

Accessing non-volatile or application log memory can delay the service tool scan.

Product ratings

Electrical

Supply voltage

Description	Unit	Minimum	Maximum	Comment
DC supply voltage	V	9	63	With reverse polarity protection
DC supply current (circuit board only)	A	0	1	UBat = 14 V
		0	0.5	UBat = 28 V
Power supply interruption (without rebooting)	ms	—	—	200 ms

5 V reference output

Description	Unit	Minimum	Maximum
Output voltage	V	4.8	5.2
Output current	A	0	0.5
Output short circuit	A	—	1
Short circuit protection	V	0	70

Warning

Output pins produce high voltage. High voltage can cause fire and/or electrical shock, if flammable gasses or chemicals are present, can cause an explosion. To protect against product damage and possible injury, do not exceed power supply voltage ratings and do not store this product where flammable gasses or chemicals are present.

Environmental

General

Description		Units	Minimum	Maximum	Comment
Operating temperature	DP600TM and DP610TM	°C [°F]	-30 [-22]	70 [158]	—
Storage temperature		°C [°F]	-40 [-40]	85 [185]	—

Warning

Excessive high/low operating/storage temperatures can damage electronics. Damaged electronics can result in performance failure. To protect against product damage and possible injury, do not operate/store product in a environment that exceeds specified temperature ratings.

Testing criteria

Climatic

Condition	Rating
Cold/heat storage and operation	IEC 60068-2-1, IEC 60068-2-2
Fogging	IEC 60068

Product ratings

Climatic (continued)

Condition	Rating
Temperature change	IEC 60068-2-14
Moisture ingress	IEC 60529

Chemical

Condition	Rating
Chemical resistance	ISO 16750-5

Mechanical

Condition	Rating
Vibration, resonance	IEC 60068-2-6
Vibration, operation	IEC 60068-2-64
Bump	IEC 60068-2-29
Shock	IEC 60068-2-27
Free fall	IEC 60068-2-32

Maintenance guidelines

! Caution

Warranty will be voided if device is opened.
Device is not field serviceable. Do not open the device.

LCD module

! Caution

Prolonged exposure to direct intense sunlight can cause premature failure of the LCD module. This risk can be reduced by providing shading or mounting the display at an incline rather than the horizontal.

! Caution

The protective glass will break if hit with a hard or heavy object. If the protective glass is broken, remove the display from your machine then return the display to Danfoss to be serviced.

Clean the display's housing and protective glass with a clean, soft, damp cloth, or mild dishwashing detergent because abrasive pads or solvents, including alcohol, benzene, and paint thinner can cause scratching and discoloration.

Installation

Dimensions

DP600TM and DP610TM in millimeters [inches]

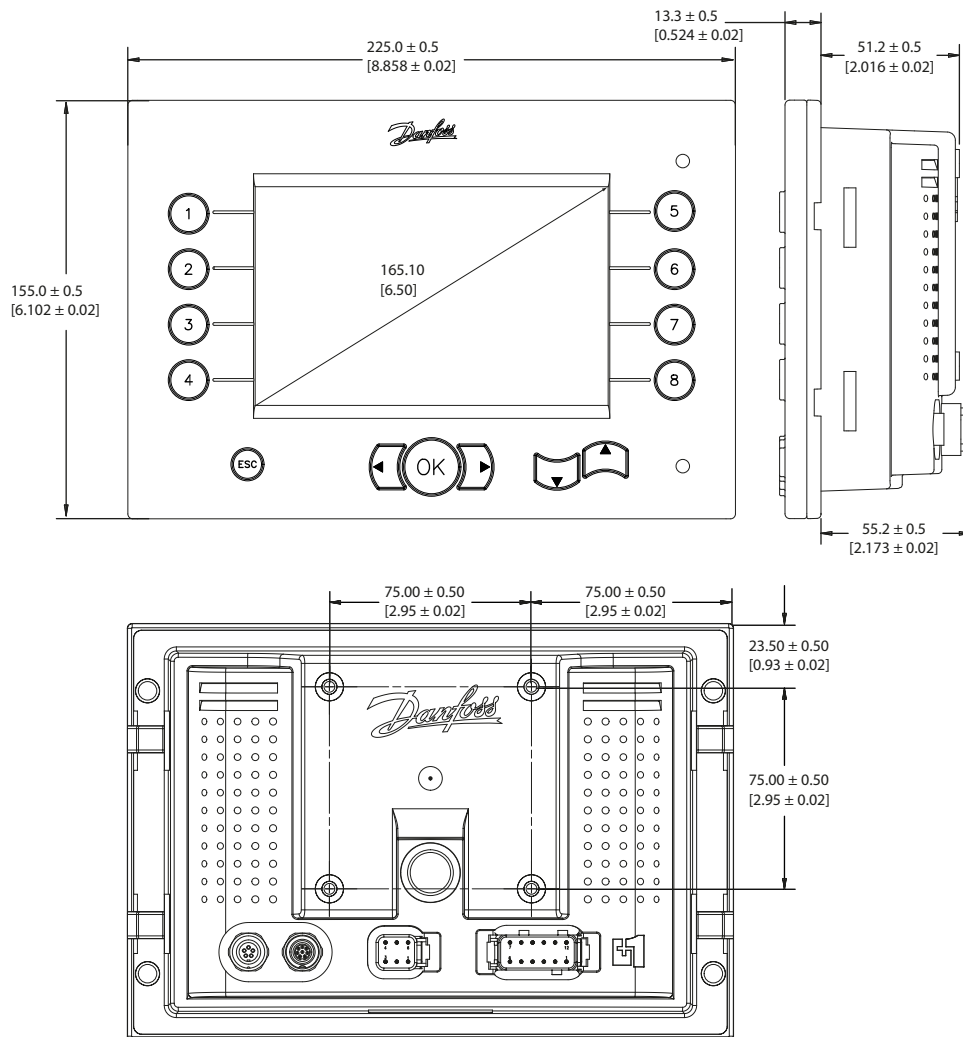

P200095

Installation

Two mounting options

Flush mounted

Use the DP6XXTM panel mounting spring clip to flush-mount display into a dashboard.

Panel cutout in millimeters [inches] and panel mounting spring clip

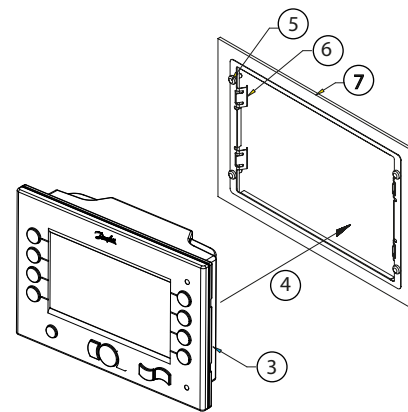
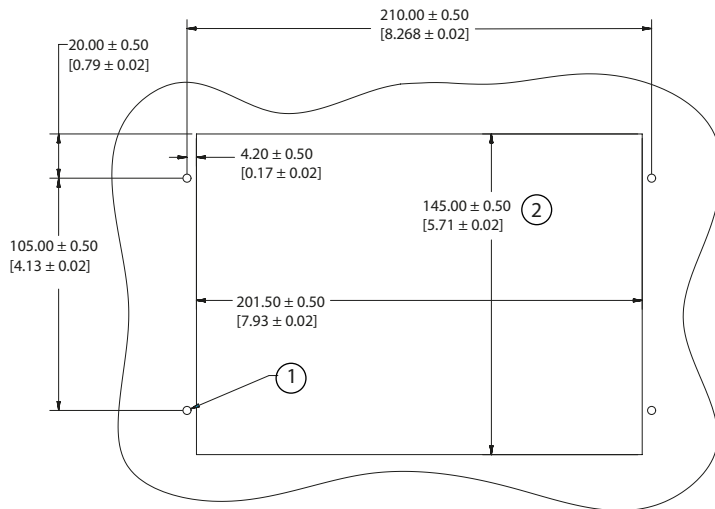

P200164

1. 4 holes for M4 x 4 screws
2. Panel cutout
3. Display assembly
4. Snap in
5. M4 x 4 screw
6. Spring clip
7. Panel

Installation

Stand-alone on post

1. Mount according to VESA (Video Electronics Standards Association) Mount Standards The VESA hole pattern for this display is: 75.00 mm x 75.00 mm (02.95 in x 02.95 in).

Post mounting option (mm [in])

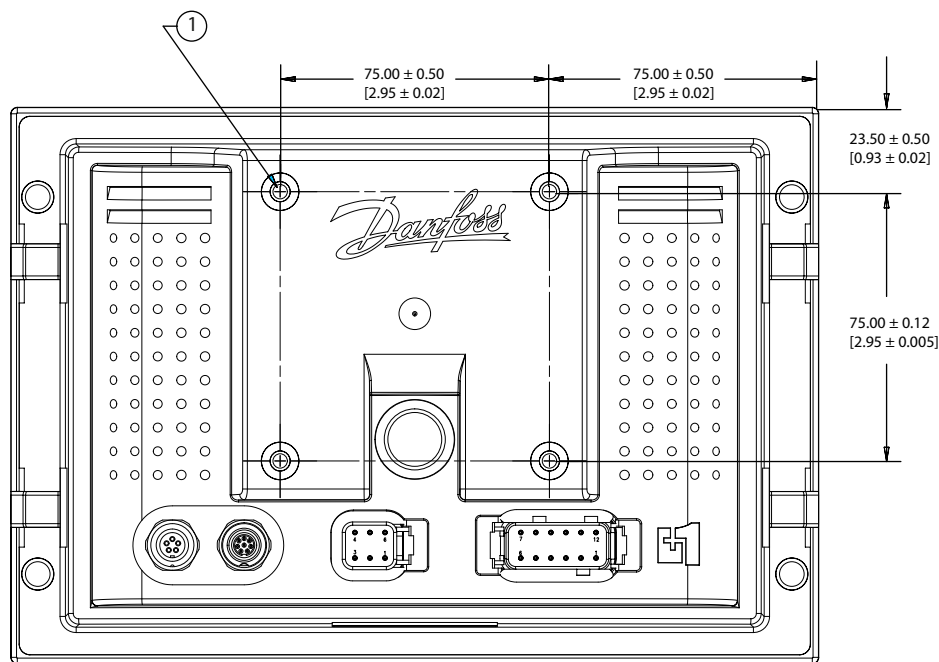

P200161

Installation

- 4 x hole for M4 screw x 0.7 mm (0.03 in) x 11 mm (0.43 in) maximum depth
2. Disconnect your machine's battery power before connecting power and signal cables to the display.

Pin assignments

DP6XXTM pin assignments

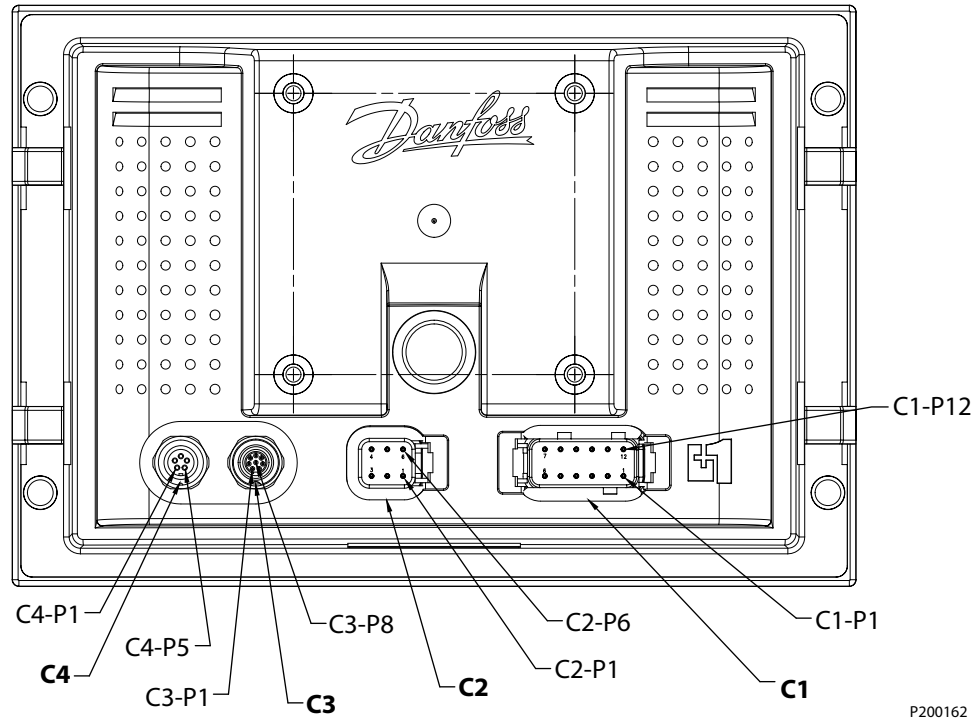

P200162

Pin connectors

C4



C3



C2



C1

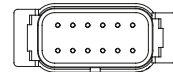

P200163

Binder 702 series 5-pin		Binder 702 series 8-pin		Deutsch DTM06 6-pin		Deutsch DTM06 12-pin	
C4 pin	Function	C3 pin	Function	C2 pin	Function	C1 pin	Function
1	Power Ground	1	USB Device Vbus	1	Battery Ground	1	Power Ground -
2	Power Supply	2	USB Device Data -	2	Redundant Power Supply	2	Power Ground +
3	Video 1 In	3	USB Device Data +	3	Redundant CAN0 High+	3	CAN1 High +
4	Signal Ground	4	USB Device Ground	4	Redundant CAN0 Low-	4	CAN1 Low -
5	Video 2 In	5	USB Host Ground/RS232	5	CAN Shield/AIN	5	AIN/CAN Shield
		6	USB Host Data +/RS232 RxD	6	Digital/AIN	6	CAN0 High +
		7	USB Host Data -/RS232 TxD			7	CAN0 Low -
		8	USB Host Vbus			8	Sensor Supply
						9	Multifunction-Input
						10	Multifunction-Input

Installation

Binder 702 series 5-pin		Binder 702 series 8-pin		Deutsch DTMO6 6-pin		Deutsch DTMO6 12-pin	
C4 pin	Function	C3 pin	Function	C2 pin	Function	C1 pin	Function
						11	Analog/Digital Input
						12	Digital Output

Machine wiring guidelines

Warning

Unintended movement of the machine or mechanism may cause injury to the technician or bystanders. Improperly protected power input lines against over current conditions may cause damage to the hardware. Properly protect all power input lines against over-current conditions. To protect against unintended movement, secure the machine.

Caution

Unused pins on mating connectors may cause intermittent product performance or premature failure. Plug all pins on mating connectors.

- Protect wires from mechanical abuse, run wires in flexible metal or plastic conduits.
- Use 85° C (185° F) wire with abrasion resistant insulation and 105° C (221° F) wire should be considered near hot surfaces.
- Use a wire size that is appropriate for the module connector.
- Separate high current wires such as solenoids, lights, alternators or fuel pumps from sensor and other noise-sensitive input wires.
- Run wires along the inside of, or close to, metal machine surfaces where possible, this simulates a shield which will minimize the effects of EMI/RFI radiation.
- Do not run wires near sharp metal corners, consider running wires through a grommet when rounding a corner.
- Do not run wires near hot machine members.
- Provide strain relief for all wires.
- Avoid running wires near moving or vibrating components.
- Avoid long, unsupported wire spans.
- Ground electronic modules to a dedicated conductor of sufficient size that is connected to the battery (-).
- Power the sensors and valve drive circuits by their dedicated wired power sources and ground returns.
- Twist sensor lines about one turn every 10 cm (4 in).
- Use wire harness anchors that will allow wires to float with respect to the machine rather than rigid anchors.

Machine welding guidelines

Warning

High voltage from power and signal cables may cause fire or electrical shock, and cause an explosion if flammable gasses or chemicals are present.

Disconnect all power and signal cables connected to the electronic component before performing any electrical welding on a machine.

The following is recommended when welding on a machine equipped with electronic components:

Installation

- Turn the engine off.
- Remove electronic components from the machine before any arc welding.
- Disconnect the negative battery cable from the battery.
- Do not use electrical components to ground the welder.
- Clamp the ground cable for the welder to the component that will be welded as close as possible to the weld.

Products we offer:

- Bent Axis Motors
- Closed Circuit Axial Piston Pumps and Motors
- Displays
- Electrohydraulic Power Steering
- Electrohydraulics
- Hydraulic Power Steering
- Integrated Systems
- Joysticks and Control Handles
- Microcontrollers and Software
- Open Circuit Axial Piston Pumps
- Orbital Motors
- PLUS+1® GUIDE
- Proportional Valves
- Sensors
- Steering
- Transit Mixer Drives

Danfoss Power Solutions is a global manufacturer and supplier of high-quality hydraulic and electronic components. We specialize in providing state-of-the-art technology and solutions that excel in the harsh operating conditions of the mobile off-highway market. Building on our extensive applications expertise, we work closely with our customers to ensure exceptional performance for a broad range of off-highway vehicles.

We help OEMs around the world speed up system development, reduce costs and bring vehicles to market faster.

Danfoss – Your Strongest Partner in Mobile Hydraulics.

Go to www.powersolutions.danfoss.com for further product information.

Wherever off-highway vehicles are at work, so is Danfoss. We offer expert worldwide support for our customers, ensuring the best possible solutions for outstanding performance. And with an extensive network of Global Service Partners, we also provide comprehensive global service for all of our components.

Please contact the Danfoss Power Solution representative nearest you.

Comatrol

www.comatrol.com

Turolla

www.turollaocg.com

Hydro-Gear

www.hydro-gear.com

Daikin-Sauer-Danfoss

www.daikin-sauer-danfoss.com

Local address:

**Danfoss
Power Solutions (US) Company**
2800 East 13th Street
Ames, IA 50010, USA
Phone: +1 515 239 6000

**Danfoss
Power Solutions GmbH & Co. OHG**
Krokamp 35
D-24539 Neumünster, Germany
Phone: +49 4321 871 0

**Danfoss
Power Solutions ApS**
Nordborgvej 81
DK-6430 Nordborg, Denmark
Phone: +45 7488 2222

**Danfoss
Power Solutions Trading
(Shanghai) Co., Ltd.**
Building #22, No. 1000 Jin Hai Rd
Jin Qiao, Pudong New District
Shanghai, China 201206
Phone: +86 21 3418 5200

Danfoss can accept no responsibility for possible errors in catalogues, brochures and other printed material. Danfoss reserves the right to alter its products without notice. This also applies to products already on order provided that such alterations can be made without changes being necessary in specifications already agreed. All trademarks in this material are property of the respective companies. Danfoss and the Danfoss logotype are trademarks of Danfoss A/S. All rights reserved.