

Energy metering | SonoSelect™ energy meter

Knowledge and innovation
to win at every project stage
SonoSelect™ energy meter

Best-in-class ultrasonic energy meter from the world's leading heating experts.

App

control for on-site
verification of
functionality, read-
outs and more.

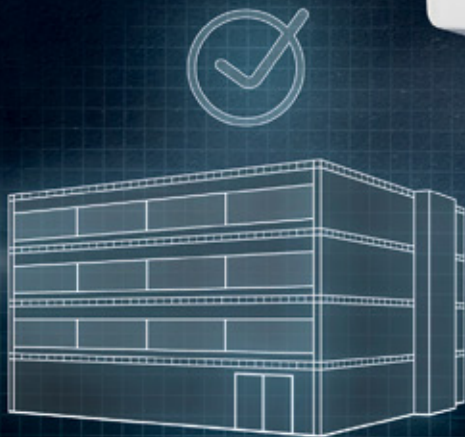

SonoSelect™

Precision energy metering made simple

From developed nations to emerging economies, energy and climate control is top of national agendas across the globe. Achieving sustainable energy consumption reductions in a world of ever-changing conditions is a common goal.

The key to achieving this is to know what we are using and when. With SonoSelect™, Danfoss is making a major contribution to solving a global challenge.

Based on precision ultrasonic technology, the new SonoSelect™ energy meter delivers the level of accuracy and reliability needed to help meet our most demanding energy management challenges.

The key to providing stable, reliable and consistent energy data.

Value in all project stages



Alongside its advanced functionality, SonoSelect™ has been designed to create value at every project stage – from product selection to aftersales service.

SonoSelect™

Ultrasonic energy meter

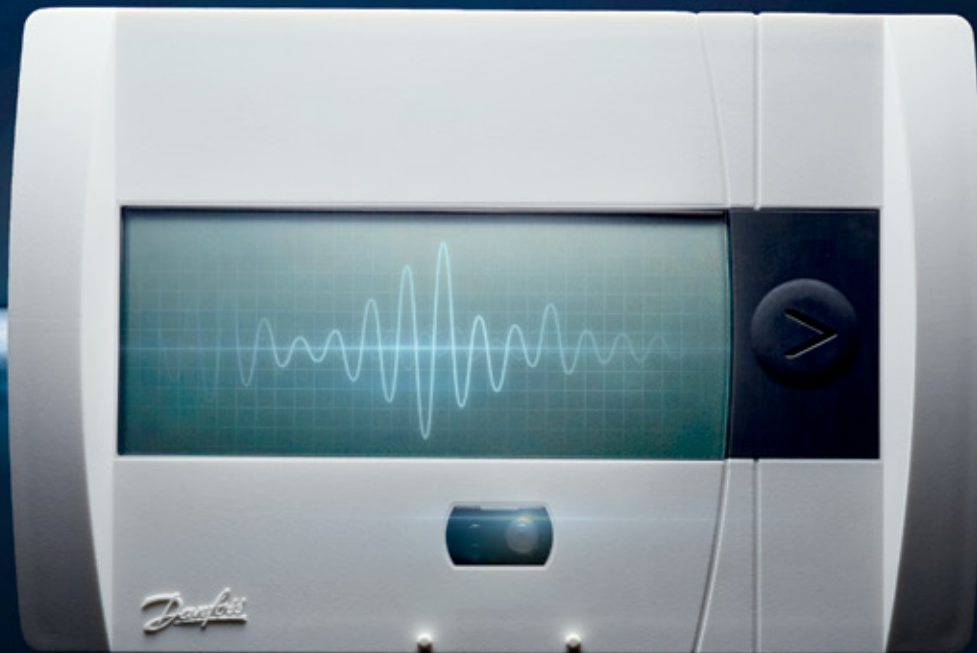

Next generation ultrasonic energy meter

**A new level of installation and
commissioning simplicity using SonoApp**

**Continuous high-performance
measurement**

**for heating-, cooling- or combined heating
and cooling applications**

**Genuine diagnostics:
Meter validation without
dismantling the meter**

Best-in-class battery life

Upgradable communication platform

Vacuum resistant transducers

Fast measuring cycles

A new approach to operational design

Next-generation ultrasonic energy meter

SonoSelect™ sets a whole new standard in energy metering. With a wide variety of innovative and unique features, it is simple to install and commission and delivers continuous high-performance measurements, even under harsh ambient temperature conditions.

One of SonoSelect's key features is that all its advanced functionality can also be controlled via smartphone using the innovative SonoApp. Complex functions can easily be programmed and routine adjustments have been made faster to access and simpler to carry out. The high level of usability reduces errors and ensures minimized installation time.

Keychain SonoDongle:

Your key
to knowledge

SonoDongle is a simple Bluetooth™ connector that enables easy communication between phone and energy meter via SonoApp. It connects to SonoSelect™ magnetically, ensuring secure and stable connection.

Compatible with Android (OS), which automatically connects to SonoApp.



Work is easy with **SonoApp**

SonoSelect™ represents the next generation in energy metering and can be used for everything from real-time verification of system functionality to rapid location pairing and error handling. All via clear and intuitive menu screens.

Moving advanced functionality to the SonoApp makes the SonoSelect™ energy meter easier to work with and reduces the risk of incorrect setting. It has also made it possible to add functionality that would not otherwise be achievable.

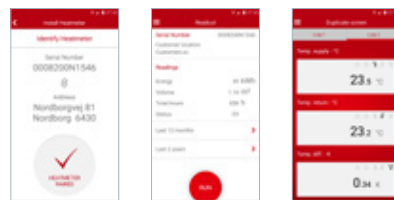

SonoApp key features

- Enables full configuration and reconfiguration control
- One-step verification of all system parameters
- Designed for simple and accurate installation
- Quick and easy to change meter settings
- Access to data log memory for fast and accurate diagnostics
- Quick and simple pairing, with no paperwork

Continued re-configuration and data access ensures efficient meter handling.

SonoApp

Reduces time spent on read-out, configuration and commissioning.

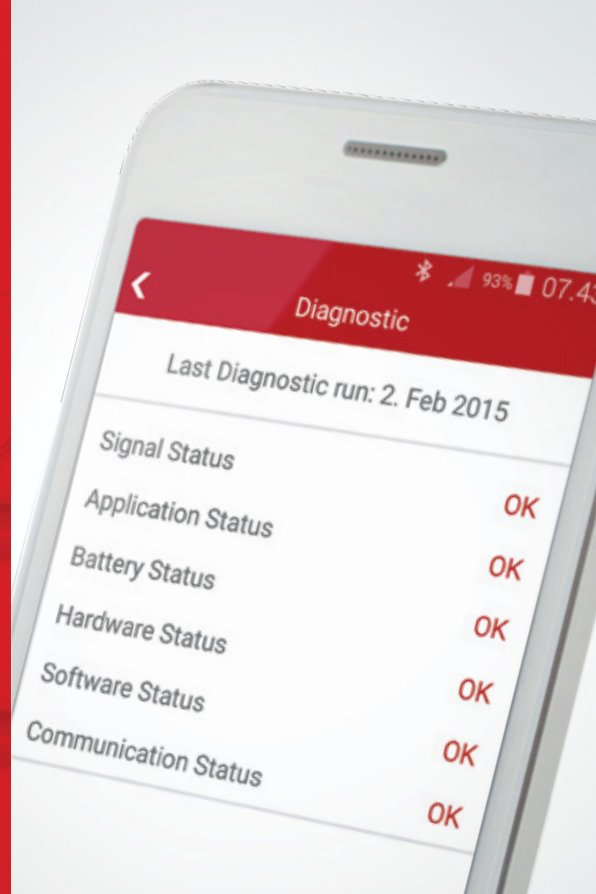
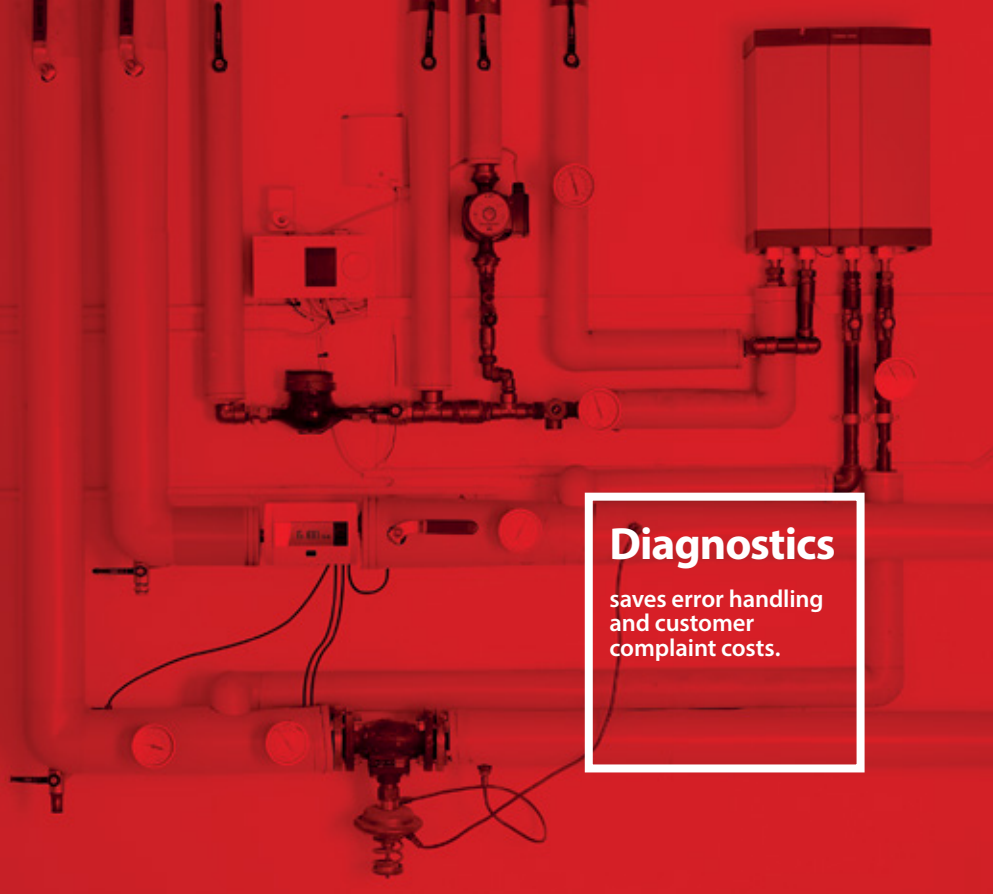

The knowledge to act

Genuine diagnostics

SonoSelect™ offers state-of-the-art diagnostic features via the SonoApp – so far only known from process industry meters. Many systems claim to have “diagnostics” when this often means little more than displaying an error code. In contrast, SonoSelect™ features genuine diagnostics with accurate traceability for fast error identification and correction. If the unit needs servicing, it is easy to identify root causes using pinpoint error identification instead of guesswork.

Confirm correct installation in a single step

Function test run from the App confirms that there are no alarms and ensures that meter values are within acceptable limits.

- Saves costs by eliminating second-guessing and ensures correct installation - even for inexperienced installers
- Reduces installation costs thanks to fewer faulty installations and call-backs

Advanced diagnostics for cost-efficient service and maintenance

Diagnostics run from the app automatically generate detailed information on vital energy meter and application parameters: e.g. battery life prognosis, potential for re-verification instead of replacement, EMC or air bubble problems.

- Less time spent on trial-and-error troubleshooting, even for inexperienced installers
- Eliminates the cost of unnecessary or untimely energy meter replacement
- Reduces costs related to customer complaints and dissatisfied customers

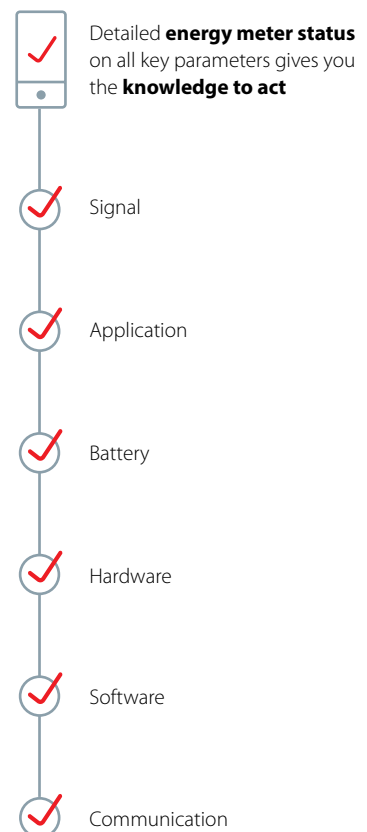

Precision and reliability

Advanced ultrasonic technology

SonoSelect™ combines years of expertise with leading ultrasonic technology to provide a new level of consistent metering precision over a long working lifetime.

Flow measurement remains extremely stable, even at low flow rates and with low-quality water. Ultrasonic technology also ensures a long lifetime with continuous reliable performance and little to no maintenance. A true long-term win/win.

Advantages of ultrasonic technology

- High dynamic range (covers large spread of rated flow)
- Stable for low-quality water (no moving flow parts)
- Low pressure losses
- Can detect even low minimum flow rates
- Continuous high measurement accuracy ensures long operational life
- Low energy consumption – increasing battery life
- Low cost of maintenance and ownership
- Several re-verifications possible throughout lifetime

Optimizes total cost of ownership.

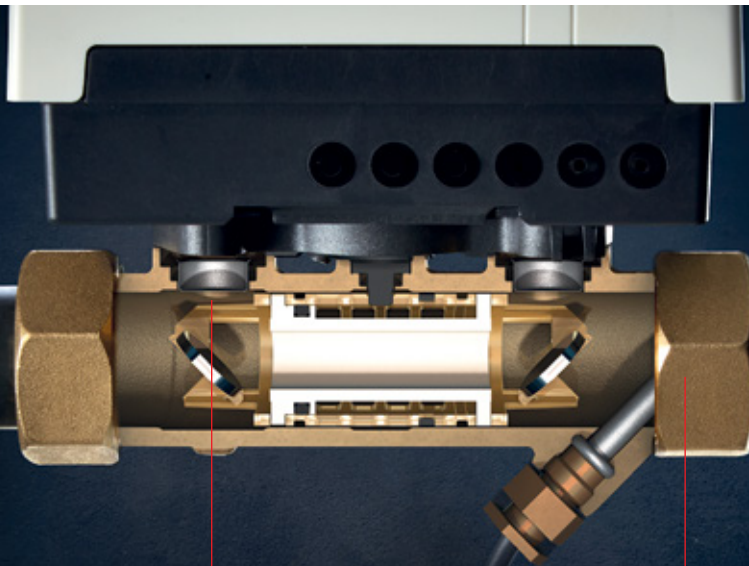

Innovative transducer design
Vacuum resistant for increased reliability

High-frequency measurement:

- Flow and energy measured every 0.5 seconds (class leading)
- Temperature measured every 4 seconds (class leading)
- Makes it possible to measure domestic hot water consumption

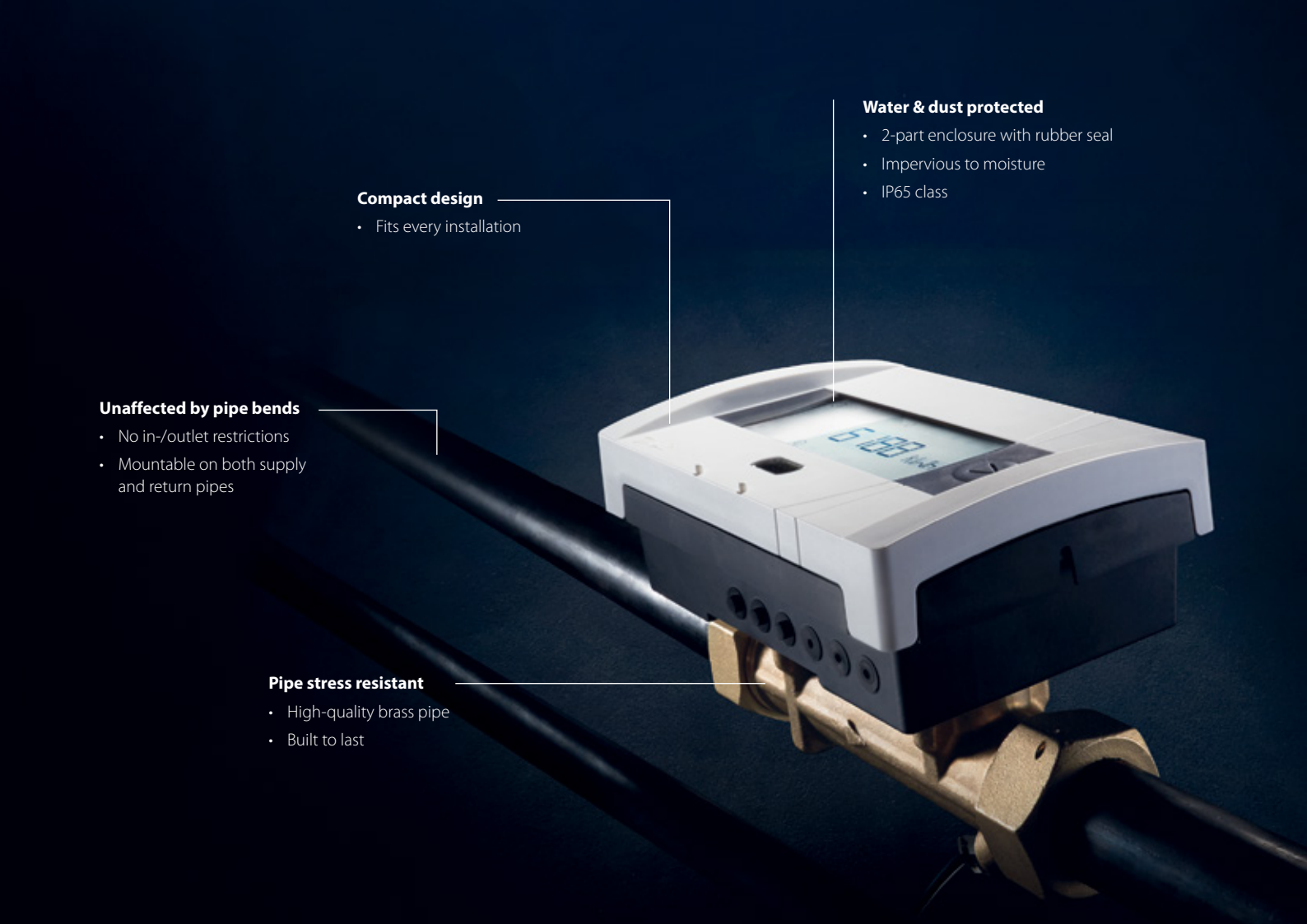

Water & dust protected

- 2-part enclosure with rubber seal
- Impervious to moisture
- IP65 class

Compact design

- Fits every installation

Unaffected by pipe bends

- No in-/outlet restrictions
- Mountable on both supply and return pipes

Pipe stress resistant

- High-quality brass pipe
- Built to last



A new level of installation and commissioning **simplicity**

The flexible choice

Robust and versatile, suitable for all applications

SonoSelect™ is compatible with virtually any application conditions. Its compact size makes it easy to fit in a wide variety of installation types and accuracy ensured regardless of pipe bends.

To ensure long-term reliability, SonoSelect™ has been designed without moving parts. Added to this are the tough cable fixtures, innovative transducer design and quality materials we have used throughout its construction to provide years of reliable operation.

Getting it right first time
Installation **simplicity**
with on-site verification

SonoSelect™ has been developed to make life as easy as possible for installers. From the robust enclosure and simple display to the intuitive and smart functions of SonoApp, SonoSelect™ has been thoughtfully designed to save time, reduce product costs and minimize reinstallations.

Installer highlights

- Configure menu: everything the installer needs in one central place
- Function test: one-click verification of functionality
- Supply/return configuration: easily change where the energy meter is installed
- Protected PCB: a sealing plate prevents accidental damage to the PCB when opening the meter
- Handy installation guides: always up to date and ready

The reliable choice – for easy product selection

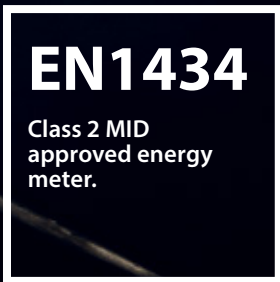

Target
applications

SonoSelect™ has been specially developed to cover the maximum range of applications, **from private homes to commercial buildings.**



1-2 FAMILY HOUSES

- ✓ New build
- ✓ Renovation



MULTI-FAMILY HOUSES

- ✓ New build
- ✓ Renovation



LIGHT COMMERCIAL

- ✓ New build
- ✓ Renovation

Reliable longevity

A lifetime of performance

SonoSelect™ has been developed to deliver consistent and credible data through its entire lifetime. To ensure this, everything from energy efficiency and battery forecasting to user management and upgradeability has been meticulously designed and engineered.

Whether you are an installer, a system manager or a building owner, SonoSelect™ will let you experience the value of next-level energy metering.

17 years of battery life, guaranteed

SonoSelect™ is incredibly energy efficient. Its two batteries are developed to last for 17 years at ambient temperatures of up to 45 degree Celsius.

Intelligent forecast: SonoSelect™ measures battery environment temperature and automatically adjusts expected battery life.

Easily replaceable batteries:

Replacing batteries is easy, and can be done without tools or risk of damaging the PCB board inside. This helps to extend the life of the meter.

230V mains powered:

Replacing batteries can be avoided when using a 230V mains powered version of SonoSelect™

Flexible and efficient - with increased product lifetime

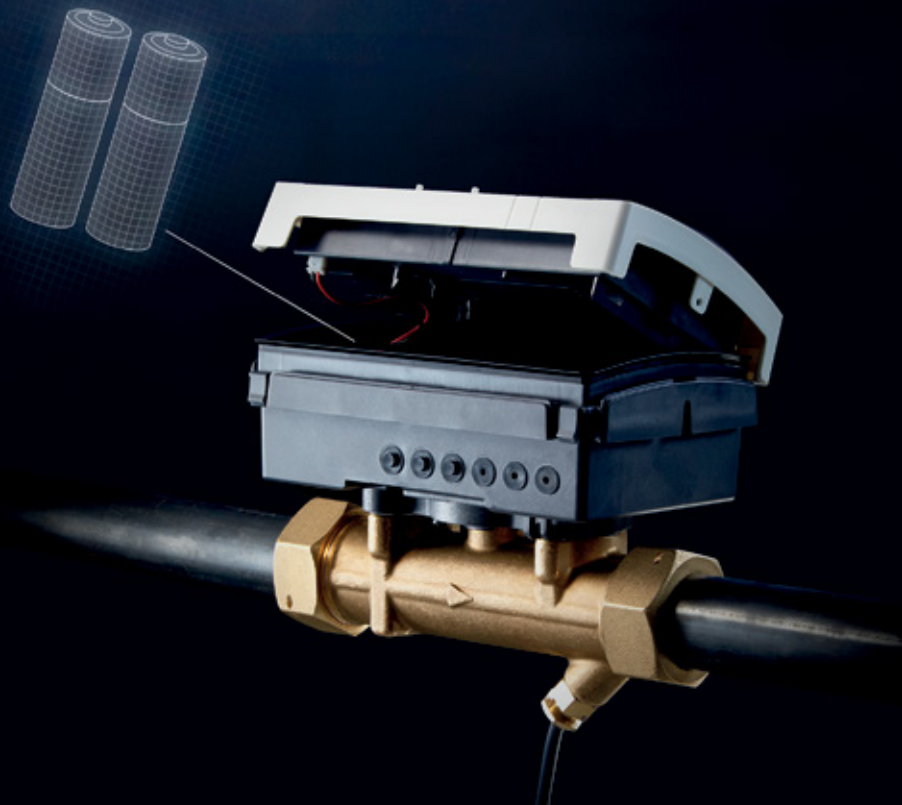

17 years

of battery life,
reduces costs for
replacements.

Differentiated access control

Multi-layer access control allows you to define users and levels of access. This enables different people to perform different tasks, depending on their skill levels.

Adding and removing users, defining access and more, is all done through the administrator page at sono.danfoss.com.

Simple, easy and with full control.

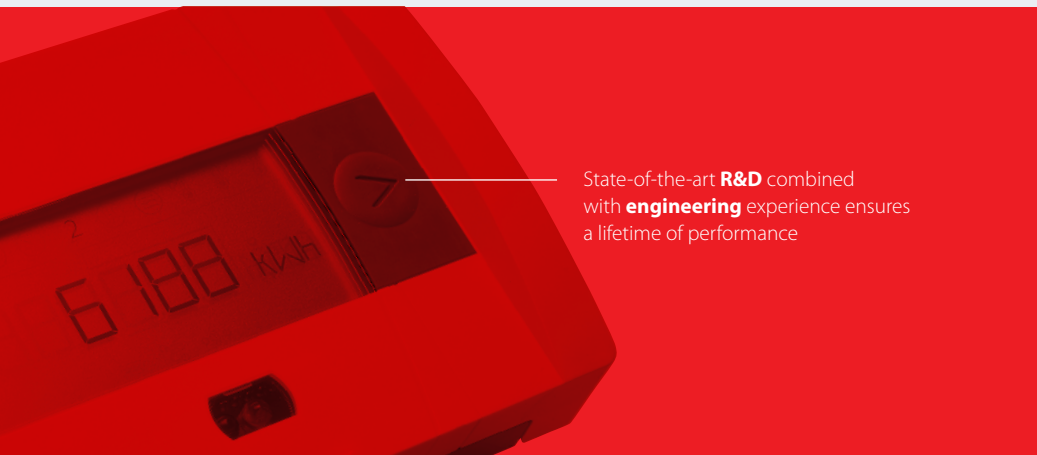
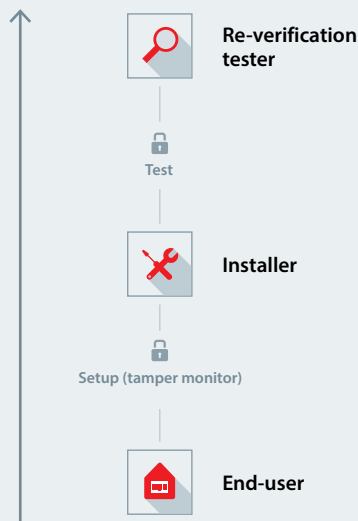

State-of-the-art **R&D** combined with **engineering** experience ensures a lifetime of performance

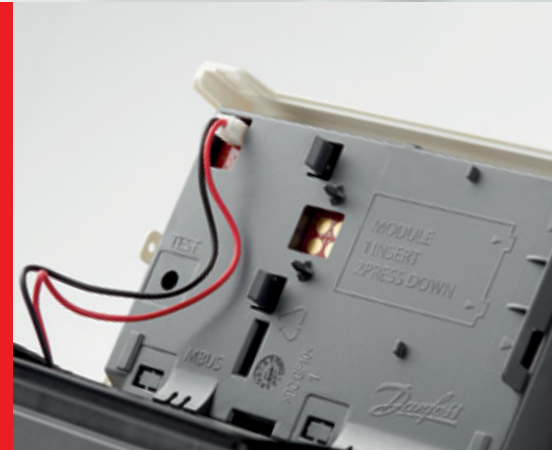

Automatic Meter Reading

Data transfer for billing can be performed via AMR (automatic meter reading) with no need for an onsite visit. SonoSelect™ can be upgraded with a communication module at any time, giving you the flexibility to specify the meter before or after the heating or cooling system has been installed.

Future upgrade: for maximum flexibility and cost effectiveness, SonoSelect™ can be easily upgraded after installation.



Alarms and error handling

In the event of unauthorized access, an instant alarm is triggered on the meter display and the administrator page.

Faulty or damaged meters can be rapidly detected and any attempted manipulation immediately dealt with. This prevents potential payment disputes between tenant and energy supplier while reassuring tenants that they have been accurately charged for energy they have actually used.

Next-generation energy meters from a **reliable** global partner

Danfoss has decades of experience in energy meters and Automatic Meter Reading and has some of the world's most advanced R&D facilities. Constant optimization and continuous improvement of products and processes are your guarantee of creating win/win situations at all project stages.

Danfoss production and quality control standards are based on the tough TS16949 standard used in the automotive industry. With global sales and technical support networks, Danfoss is present in all major markets, ensuring short lead times, efficient logistics and locally based after sales service.

When it comes to meeting the next generation of challenges in energy metering and energy consumption reduction, you can rely on Danfoss expertise.



To learn more about SonoSelect™
visit sono.danfoss.com

Danfoss A/S · Heating Segment · 6430 Nordborg · Denmark
Tel.: +45 74 88 22 22 · Email: heating@danfoss.com · www.heating.danfoss.com

Danfoss can accept no responsibility for possible errors in catalogues, brochures and other printed material. Danfoss reserves the right to alter its products without notice. This also applies to products already on order provided that such alterations can be made without subsequential changes being necessary in specifications already agreed. All trademarks in this material are property of the respective companies. Danfoss and the Danfoss logotype are trademarks of Danfoss A/S. All rights reserved.