

Whitepaper

# Practical guidelines for **creating energy efficient** multi-family residential **heating systems**

**Learn**

how to create  
complaint free and  
energy efficient  
two-pipe radiator  
heating systems

**Content of this document**

1. Purpose of this whitepaper
2. Introduction
3. Most recognized problems in practice
4. What should you master?
5. How do you master?
6. Products
7. Energy saving expectations
8. Conclusion

**1. Purpose of this whitepaper**

This whitepaper is intended to support heating professionals with creating complaint free and energy efficient two-pipe radiator heating systems in (multi-family residential) buildings. The guidelines are relevant for retrofit, renovation as well as new construction situations. You can expect clear and practical to use explanations and recommendations. Topics such as results-based savings, balancing methods, water quality and energy consumption of pumps are brought together by specialists from Danish manufacturers Danfoss A/S and Grundfos A/S to provide you a document with a complete solution.

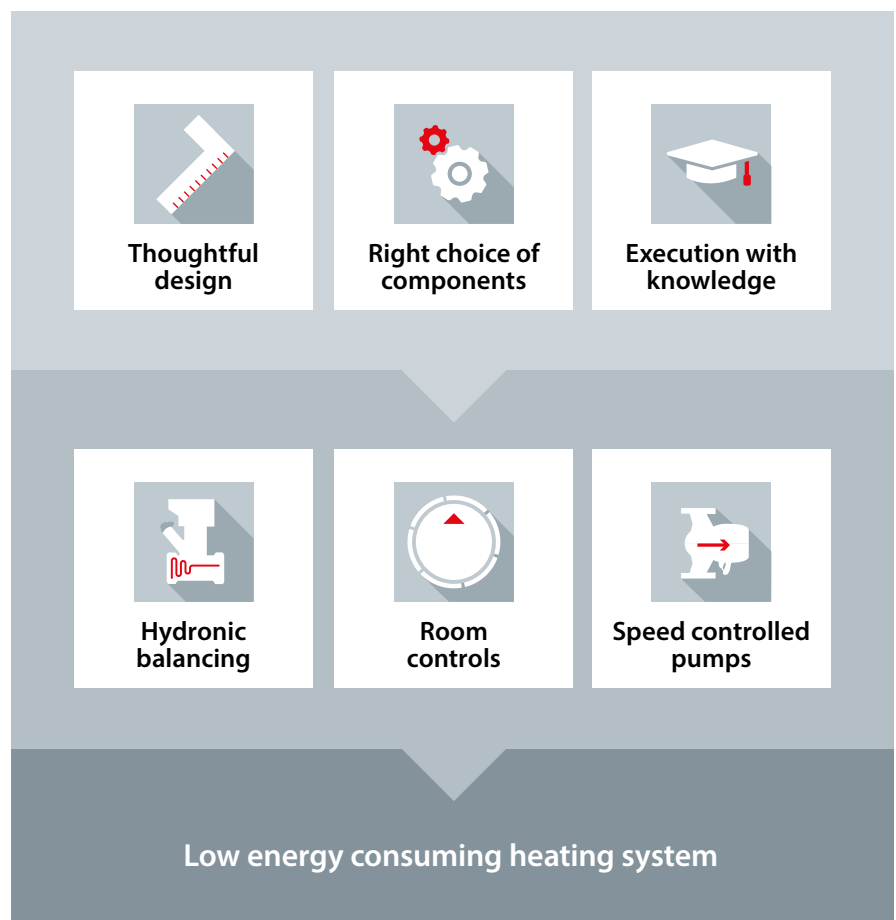

## 2. Introduction

To comply with the Kyoto climate protocol agreement and to honor its commitment to reduce CO<sub>2</sub> emission in the long term, Europe is determined to reduce energy consumption among its 28 member countries. In order to achieve this the Energy Performance of Buildings Directive (EPDB) was established, stating a number of energy saving measurements for member countries to follow.

> EPDB European directive

### 2.1 Saving energy in buildings is a must

As figures prove, buildings use 40% of the regions total energy consumption. With such a significant contribution to the energy consumption it is clear that the heating systems in buildings are an important topic for improvements during new construction, retrofit and renovation. Compared to high impact solutions such as building insulation and implementing renewable energy sources, optimizing pump technologies, creating automatic hydronic balancing and achieving accurate temperature control are nowadays recognized to be a cost effective way to reduce the energy consumption of buildings. This is the moment where you as a heating professional come into play.



### 2.2 So far the focus was on solving

Besides the renewed scope for energy saving a lot of heating professionals know about the challenges in creating a well-functioning two-pipe radiator heating system. In many occasions where residents complain about heating system noise and lack of comfort these are attempted to be solved by e.g. experimentally adjusting heat curves of a boiler or other heat source, increasing the pump head capacity or by installing, balancing valves. Besides the fact the complaints are seldom fully solved these measures are conflicting with the EPDB stated need for reduction of energy consumption in buildings and overall increase of the amount of energy used.



2.3 A new approach to buildings' heating systems

To actually solve the complaints as well as reducing energy consumption a new approach for heating systems in buildings is required. A good design, the right choice of products and quality of execution often require just a limited additional investment but they result in a long-term high performance. This is essential for building owners who want to make investments that suit their corporate social responsibility. Design flow and temperature must be guaranteed in both full and partial load conditions to achieve the efficiency as well as provide the best possible comfort for the residents.

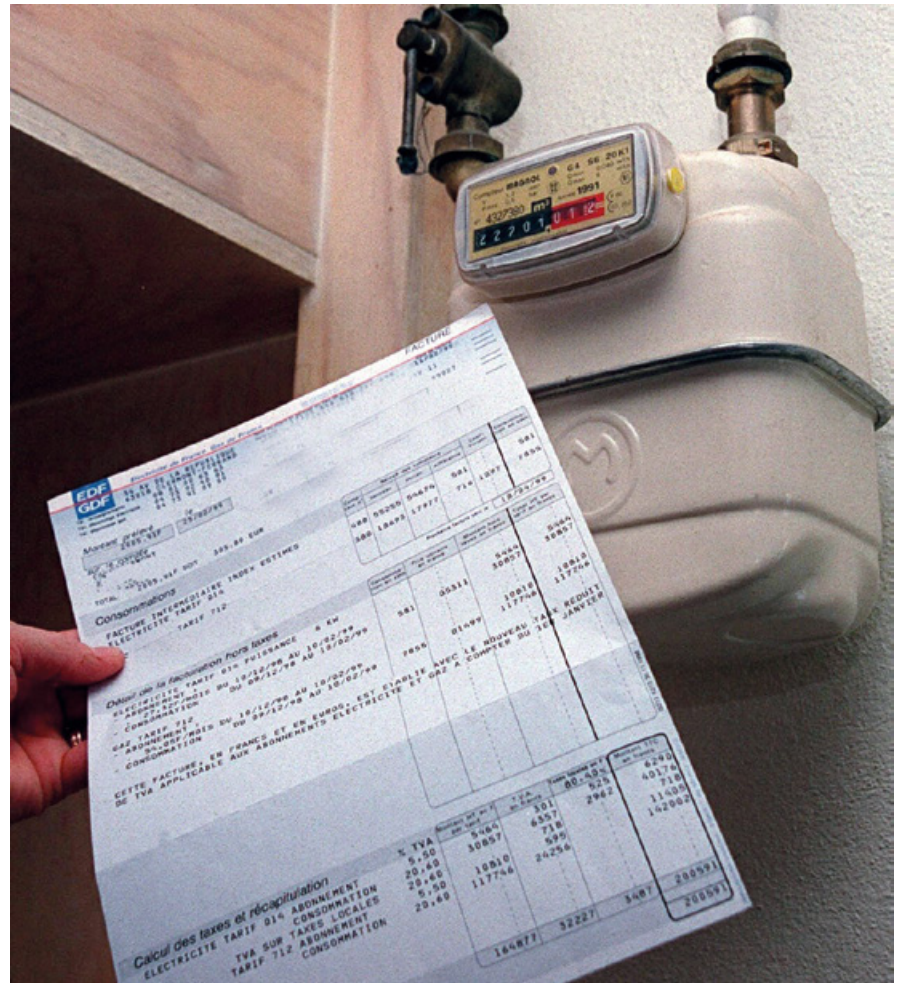

### 3. Most recognized problems in practice

Communal heating seems a shot on target when it comes to the application of renewable energy sources in new construction buildings. Unfortunately, in existing buildings these systems have a negative image due to noise issues, discomfort and high energy consumption. All these symptoms can be traced back to the fact that over 80% of these systems are not properly hydronic balanced.

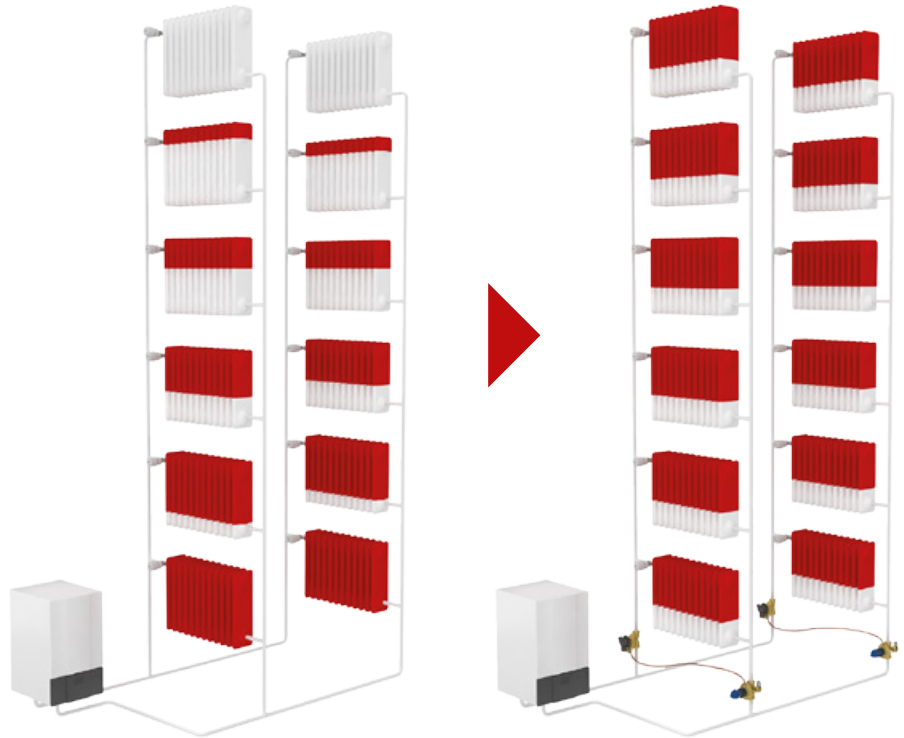

#### 3.1 Rushing sounds in heating systems

Unbalanced or not properly balanced systems result in high flows through its pipes. In many cases this applies to situations where the flow through the pipes and radiator control valves is so turbulent that it causes a rushing sound. Besides the fact that it is perceived as a complaint by the residents, turbulent flow causes unnecessary loss of heat and pressure as well.

#### 3.2 Complaints about cold

In many systems the flow through the connected radiators is 3 to 4 times ! higher as necessary for proper functioning. The consequence of this is that the pressure loss in pipes increases dramatically which results in too little pressure being available for the 'critical' radiators which are furthest away from the boiler room. Because of this a number of residents at certain parts of the day will experience symptoms such as completely or partially cold radiators, despite their need for heating. Often these complaints are solved by increasing pump head settings, installing a larger circulation pump or raising water temperature (via the weather compensators' heat curve), which of course will inevitably lead to increased energy consumption.

### 3.3 High energy costs

Many systems have to be set to higher water temperatures in order to guarantee a comfortable indoor climate for everyone. The result is that the boilers operate at a lower than optimal and possible efficiency and heat loss in transportation pipes increases. To benefit from maximum efficiency, condensing boilers must be able to achieve condensation of exhaust gas on the heat exchanger. The colder the return water temperature, the higher the rate of condensation and by that the higher the efficiency of the boiler. Systems which are not hydronically balanced will result in higher water temperatures to reach the expected comfort level. Hence, no or poor hydronic balancing has a bad influence on heat losses in transportation pipes and the efficiency of condensing boilers and heat pumps.

### 3.4 How to establish fair heat cost allocation?

Heat cost allocators are used on all installed radiators to allocate heat consumption and to generate an individual bill for each apartment. Such solution can provide transparency for the residents although often heat cost allocators are questioned by unexplained high energy bills. Many people do not know that the European DIN EN 834 norm, in annex A among other things describes the properties for heating systems that are equipped with heat cost allocators. There are 4 recommendations:

- Each radiator should be equipped with a controlling device to be operated by the user, like a radiator thermostat.
- A well-adjusted electronic weather compensator should be applied to control the flow temperature and minimize errors in the heat cost allocation.
- Heating systems should be hydronically balanced to obtain flow rates according design conditions and minimize errors in the heat cost allocation.
- The size of radiators should be determined to ensure sufficient heating.



### 3.5 Unfamiliarity with the use and application of radiator thermostats

A radiator thermostat is designed to automatically feed the right amount of heated water into a radiator which is needed to efficiently bring a room to the desired temperature. Many residents are unfamiliar with the operation of a radiator thermostat and the conditions in which it performs best. Providing the right information to the residents and choosing the right type of thermostatic sensor for the situation is often underestimated.



**4. What should you master?**

Many technical aspects in a heating system contribute to achieve an efficient system operation. Based on physical properties the below topics will clarify that all aspects must be properly prepared and executed to achieve the expected results in terms of energy saving and complaint free operation.

**4.1 Determine the necessary radiator capacity per room**

Depending local weather conditions, building construction and calculation guidelines the heat load per room should be determined. Dedicated software is often used and the outcomes are the starting point for you as heating professional.

**4.2 Determine the design flow per radiator ( $q_v$ )**

The first step in creating an efficient system by hydronic balancing is to limit the flow on each radiator. The flow that is needed (design flow) depends on flow temperature, return-temperature and the room heat load. In renovation projects room heat load and thus the capacity of the radiator can be determined by type and the dimensions. Although many calculation tools and design programs exist, it's still important to know the parameters a design volume flow is dependent on. These are specified in the below formulas to calculate the design flow:

**Full formula:**

$$q_v = \frac{P_{radiator}}{\rho \cdot c \cdot (T_{flow} - T_{return})} [m^3/s]$$

$q_v$	Design flow [m <sup>3</sup> /s]
$P_{radiator}$	Radiator capacity [W]
$\rho$	volumetric mass density of water 1000 [kg/m <sup>3</sup> ]
$c$	Specific heat of water 4190 [J/(kg.K)]
$T_{flow}$	Flow temperature [°C]
$T_{return}$	Return temperature [°C]

**Simplified formula** (be aware of the adapted units of measure !):

$$q_v = \frac{0,86 \cdot P_{radiator}}{\Delta T} [m^3/h]$$

$q_v$	Design flow [m <sup>3</sup> /h]
$P_{radiator}$	Radiator capacity [kW]
$\Delta T$	Difference between flow and return temperature [K]

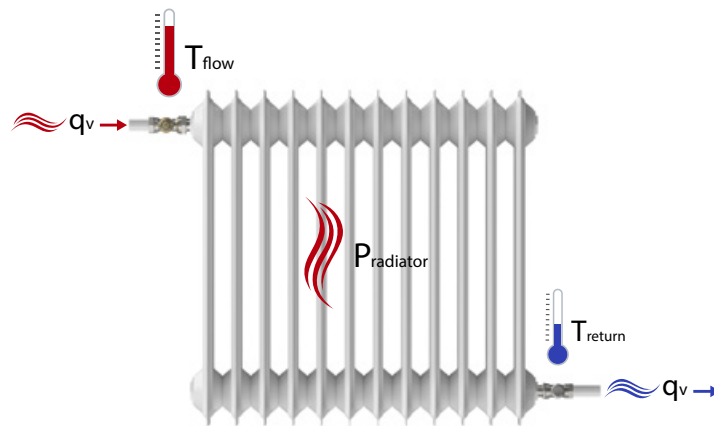

**What can we learn from above formula's?**

- The design flow is mostly dependent on room heat load, to be delivered by the installed radiator, and the difference between flow and return temperature ( $\Delta T$ ).
- Systems designed with a small  $\Delta T$  result in higher flows.

Note: Higher flows result in higher pressure losses in pipes and the need for higher pump capacity.



#### 4.3 Constrain the design flow per radiator

Constraining the flow is done by limiting the capacity (max. opening) of an installed radiator valve. To do so radiator valves with pre-setting feature are required. In addition also the pressure drop across the valve should be kept constant. To do so a pressure controller is required on either riser or radiator level. The below formula shows the relationship:

**Formula:**

$$q_{v(\text{radiator})} = K_v \cdot \sqrt{\Delta p_{(\text{valve})}}$$

$q_v$	Design flow [m <sup>3</sup> /h]
$K_v$	Valve capacity
$\Delta p$	Available pressure drop across valve [bar]

**What can we learn from above formula?**

- The design flow can only be constrained according design flow in systems where the correct pre-setting per radiator ( $K_v$ ) is done and the pressure difference is constant.

Note: In systems without flow limitation via valve pre-setting, flows and pressure losses can be exceptionally high.

#### 4.4 Set the capacity of the radiator valve ( $K_v$ )

In order to establish the design flow it is highly recommended to use a pre-setting radiator valve. Instead sometimes a lockshield valve is used but the pre-setting is less accurate, it can't be checked visually and is more difficult when it comes to workability. Each pre-setting corresponds precisely to a  $K_v$ -value which indicates the capacity of the radiator valve. The  $K_v$ -value is defined as flow in cubic meters per hour of water passing through the valve when the pressure drop across the valve is 1 bar. Many calculation tools exist to easily determine the correct pre-setting ( $K_v$ -value) for each radiator valve.



4.5 Control the differential pressure ( $\Delta p$ )

The available pressure drop across the valve should be kept as constant as possible to prevent deviations in the design flow. The only way to achieve this is through the use of differential pressure control, for example established by using automatic balancing valves or pressure independent radiator valves.

**The main reasons for using automatic balancing valves are:**

- Prevent noise in the system caused by undesirably high pressure differences during partial load conditions.
- Ensure maximum energy efficiency by reducing heat losses in pipes and increase the efficiency of boilers, heat pumps and speed controlled circulation pumps.
- Provide stable functioning of room temperature controls. Varying differential pressures result in an instable room temperature which leads to higher energy consumption.

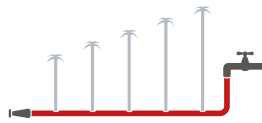

**Fig 1.** Unbalanced systems cause uneven distribution of water.

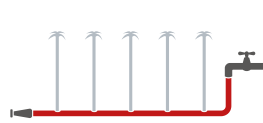

**Fig 2.** Limiting the flow on each radiator results in a uniform distribution of water, just in full load situations.

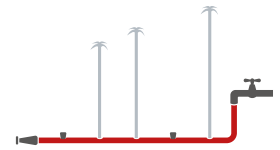

**Fig 3.** Without automatic differential pressure controllers, the distribution of water shows irregularities in partial load conditions.

4.6 Establish room temperature control

Automatic control of the flow through a radiator based on a desired room temperature is the most efficient way to gain control over residents heat consumption. Radiator thermostats consists of two main parts. A thermostatic temperature sensor is set to a desired room temperature and reacts to temperature changes caused by 'free heat' from sun power, appliances, occupants, etc. The thermostatic radiator valve (TRV) automatically adjusts the flow of water through the radiator to establish the desired room temperature.

**The main reasons for using automatic room temperature controls are:**

- Provide control and comfort to end-user.
- Minimize energy use by responding to internal and external heat load.
- Depending country specific regulations it can improve the energy label of the building.



#### 4.7 Select the best suited circulation pump

Based on the total system design flow and the total of all pressure losses a system suited circulation pump can be selected. The heat demand in a building depends on outside temperatures, insulation, sun power, internal loads and overall activity. The same is valid for the capacity demand of circulation pumps. To save money on the electricity bill speed controlled pumps can adapt their pump head capacity to the actual needs of the heating system. In partial load conditions the heating system is dynamic with variable flow demands and changing differential pressures. A speed controlled pump constantly adapts to the changing system conditions as caused by especially the many radiator valves in the system.. To select the right circulation pump you need to be familiar with the systems' exact requirements to overcome the pressure loss to the most unfavorable located radiator at all loads.

##### **The main reasons for using speed controlled pumps are:**

- Reduce electric energy use.
- Limitation of the maximum differential pressure at partial loads.
- Easy to adjust optimal pump head capacity for the heating system.



## 5. How do you master?

A new focus on creating energy efficient heating systems in buildings requires a critical look at existing methods and products to use. This has for example resulted in the fact that manual balancing valves, manual radiator valves and standard circulation pumps are more and more being replaced for automatic balancing and control solutions and speed controlled pumps. Below you can read how to create a high quality, energy efficient heating system.

### 5.1 Make the right choice of room temperature control

Each pre-setting radiator valve must be equipped with a thermostatic sensor to control the room temperature in each individual room. To guarantee the proper functioning and operability for the residents, it is important to make the right choice for the type of sensor. Three aspects have to be taken into account:

#### 5.1.1 Technical performance

Thermostatic sensors use expansion and contraction of either a wax, liquid or gas charge in a bellows to open or close the radiator valve. The more stable the room temperature, the less energy is lost due to unnecessary heating and cooling down of the room. Therefore fast response to internal and external heat load by the thermostatic sensor is a key factor when it comes to energy efficiency.

**Wax charge** - Slow response  
(reaction time ~40 min.)

**Liquid charge** - Average response  
(reaction time ~20-25 min.)

**Gas charge** - Fast response  
(reaction time ~10-15 min.)

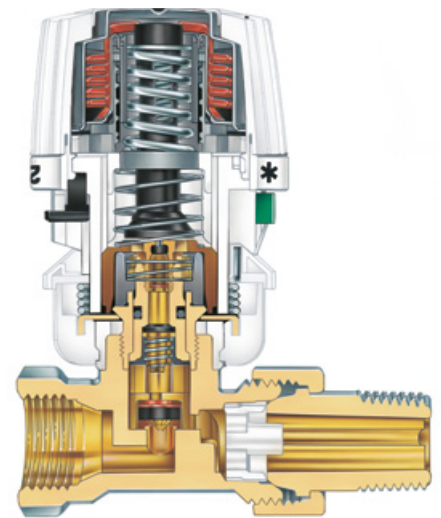

Nowadays also electronic sensors are available. These contain a small actuator and open and close the valve in many small steps depending the difference between actual measured and the desired room temperature. This provides a high accuracy. The response time is very fast but is not possible to translate into a reaction time (= time spent from fully open to fully closed valve) as this is not the way it is being controlled. These sensors contain batteries to operate the actuator and display. When selecting the sensor to use this should be taken into account as it requires replacement of the batteries periodically.



5.1.2 Influence of ambient

In situations where the ambient air can circulate freely around the sensor normally you would choose a built-in sensor. It is not uncommon for curtains, wide window sills, furniture or other obstacles hindering the free circulation of air along the element. In these situations, a version with either a remote sensor or remote sensor and setting is a more appropriate choice.



Built-in sensor



Remote sensor

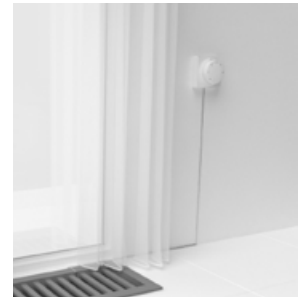

Remote sensor and setting

5.1.3 Programming capabilities

Programming a weekly schedule with day and night setback times and the corresponding temperature settings, allows residents to effectively manage their heating system. There are different solutions in the market. From simple, affordable programmable radiator thermostats to more high-end solutions that can (wireless) control all radiators in an entire apartment from one point of access. This connects better to the luxurious desires people may have. Programmable room controls are a worthwhile investment, residents can achieve a potential of up to 30% reduction in energy consumption.



5.2 Chose the best suited automatic balancing solution

As explained a proper hydronic balance is important and can only be achieved by using an automatic balancing solution that eliminates pressure fluctuations and by constraining the flow per radiator. As the formula

$$q_{v(radiator)} = K_v \cdot \sqrt{\Delta p_{(valve)}}$$

shows there are two variables (valve capacity  $K_v$  and pressure drop  $\Delta p$ ) that need to be controlled to achieve the design flow ( $q_v$ ) per radiator. When done so for all of the systems' connected radiators the hydronic balance will be in place, both in full load as well as in partial load conditions.

To meet these requirements, you can chose between two methods which are equipped with automatic pressure control and flow constraints.

**Method 1**

With a differential pressure controller per riser and pre-setting valves per radiator.

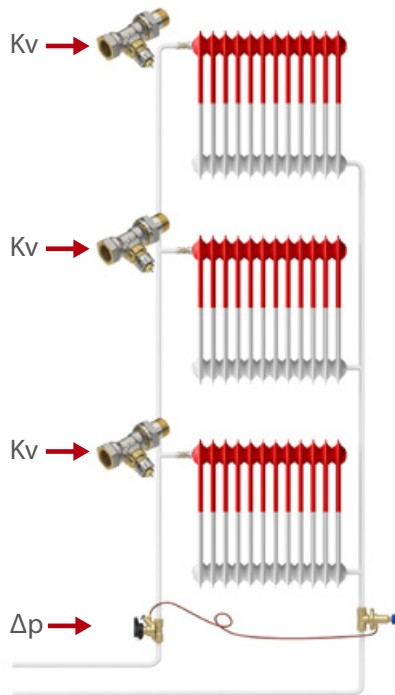

Application area:

- Systems with large number of radiators per riser.
- Systems where radiators with integrated valves are used.
- Systems with small  $\Delta T$  or large capacity radiators (high flow demand).
- Systems with existing and well-functioning radiator thermostats.
- Systems with high maximum pump head capacity.

**Method 2**

With pre-setting radiator valves having a build-in pressure controller.

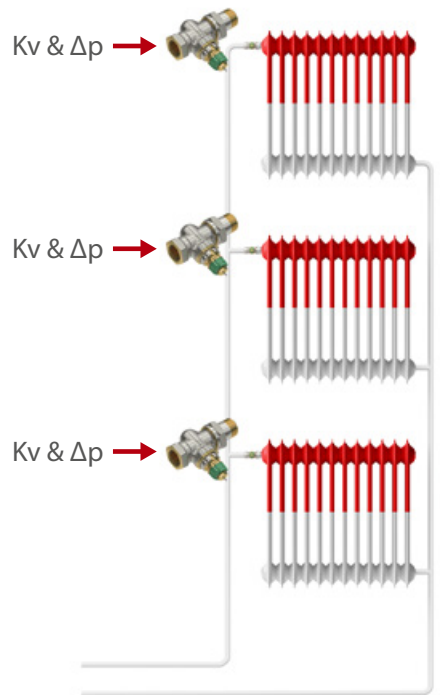

Application area:

- Systems where flow and return pipes of the risers are distant from each other.
- Systems where flow and return pipes are difficult to access.
- Systems where no risk of unexpectedly high pressure differences can arise e.g. where speed controlled pumps are used.
- Systems with limited maximum pump head capacity.

### 5.3 Use speed controlled pumps

The technical developments of recent years makes it worthwhile to examine the pump energy consumption. Modern circulation pumps are speed controlled and support the heating system by preventing differential pressure to increase at partial load conditions. The need for an automatic balancing solution is still present though as differential pressure changes at the radiators as well. This cannot be solved by the pump. Speed controlled pumps contribute to lower energy consumption of the heating system. Relating to what is known as "the Affinity laws" the power consumption of a pump is proportional of 3<sup>rd</sup> of the pump speed. This indicates the lower the pump speed is, the lower the energy consumption will be. The required pump speed is determined by the flow rate of the circulated water (at a given differential pressure demand). A conclusion can be drawn: the larger the overflows in the system are, the more power the pump will consume. Therefore the biggest benefit from speed controlled pumps can only be achieved in heating systems which have been commissioned with automatic balancing solutions and are equipped with pre-setting radiator thermostats to prevent any overflow.

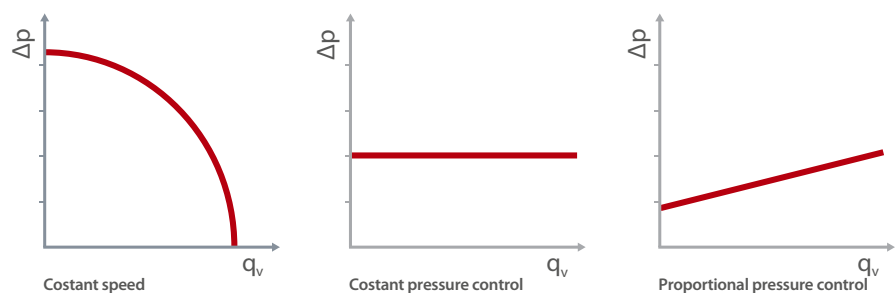

#### Which setting suits you best?

##### Constant-speed

With this setting we are able to use a modern speed controlled pump like an old conventional pump. This setting is not recommended because it will provide increasingly high differential pressure during decreasing partial load conditions. This results in unnecessary energy consumption, increased risk of rushing sounds and gives no benefit.

##### Constant-pressure control (recommended)

This setting ensures that the pump head creates no more differential pressure than necessary for the most unfavorable situated radiator in the system. By setting the maximum needed differential pressure for the system you'll create a more efficient way of water circulation and assure the right conditions for the system at all times.

##### Proportional-pressure control (recommended with certain reservation)

In theory this pump setting is perfect in combination with automatic balancing. Unfortunately there are some exceptions where this setting can lead to 'starving', an underflow situation during partial load conditions caused by a too low differential pressure. The combination of 'starving' and this proportional pump setting can cause complaints about not enough available heat in some parts of the building. This is the main reason to always be careful when you're considering this option.

*A good example is shown in the illustration to the left:*

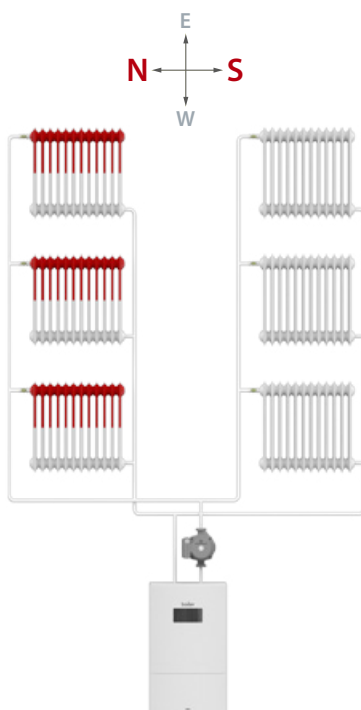

it shows two main branches in the system, one for the south side and other for the north side of a building. When the sun shines it heats up the south sided rooms and causes radiator thermostats to close. In case the pump would be set to proportional pressure control, it will follow the decreased load and reduce delivered pressure. However, the north side may still require full capacity and thus full pressure. Due to 'starving' some parts of the north side will not be provided with enough heated water causing residents to complain.

#### 5.4 Ensure correct commissioning

The procedure for commissioning heating systems that are equipped with an automatic balancing solution requires less work, less measurement operations and fewer calculations. The pre-setting of the radiator valves can easily be prepared and documented beforehand of the installation on the basis of the capacity of each radiator corresponding with the calculated heat loss per room. With the details provided in time the valves can be set to the required settings immediately after the system has been flushed to prevent dirt remains behind inside the valves.

When differential pressure controllers per riser are used (referring to automatic balancing method 1), a  $\Delta p$  setting of 10 kPa meets the characteristics of many heating systems. In some systems the required differential pressure is higher. In these cases it is important to maintain a controlled setting below 25 kPa to prevent noise issues and inaccurate functioning of the radiator valves.

Also in case radiator valves with integrated pressure controllers are used (referring to balancing method 2) a  $\Delta p$  of 10 kPa meets the characteristics of many heating systems. These valves can mostly be used up to higher differential pressures before noise issues will occur though.

Measuring the differential pressure for verifying and commissioning optimization is important to prevent failure costs and achieve extra energy efficiency. Measure the critical valve and/or riser furthest from the pump to check whether the required differential pressure is available. If it is, you can be sure of a correctly commissioned system.





## 5.5 Perform a pump optimization

Once you know the system is commissioned correctly, you can even try to lower pump head pressure settings step by step and see if the required differential pressure remains available. Doing so you're optimizing the pump setting and by that reduce its use of electricity. Systems operating with an optimized pump setting are not just more energy efficient, they are typically more reliable as well. Before performing pump optimization an index riser needs to be identified. The index riser is in most cases the one that is most distant from the pump and thereby suffering most from pressure losses in pipes. Next, during pump optimization the system needs to run at full design flow. This can e.g. be achieved by lowering the flow temperature which triggers the radiator sensors to fully open the valves.

To achieve a successful pump optimization the below sequences should be followed.

### **For automatic balancing method 1 with differential pressure controller per riser:**

- Step 1 Ensure balancing valves are pre-set to correct  $\Delta p$  value
- Step 2 Ensure all radiators valves are installed and pre-set to design flow (kv)
- Step 3 Measure the  $\Delta p$  on the index riser
- Step 4 Start with pump optimization. Reduce the set point of the pump until the measured  $\Delta p$  shows a sudden drop, below the desired  $\Delta p$ . Then slowly turn up the pump setting again until you reach the desired  $\Delta p$ .

### **For automatic balancing method 2 with radiator valves having a build-in pressure controller:**

- Step 1 Ensure all radiators valves are installed and pre-set to design flow (qv)
- Step 2 Measure the  $\Delta p$  on the index radiator valve
- Step 3 Start with pump optimization. Reduce the set point of the pump until the measured  $\Delta p$  shows a sudden drop, below the desired  $\Delta p$ . Then slowly turn up the pump setting again until you reach the desired  $\Delta p$ .



### 5.6 Ensure high water quality

The lifespan of heat exchangers, control valves and circulation pumps is very much influenced by water quality. Heating systems having a good water quality will benefit from minimal corrosion, chalk buildup, and bacterial growth. To avoid damages to the heating system components the water or water mixture should be in accordance with EN 14868 and German VDI 2035 standards. Some countries have defined other standards which have to be followed as well. For planned heating system renovations a thorough analysis of water samples is recommended. With the result of the analysis an overall solution by using the best possible combination of automatic air vents, dirt separators etc. must be realized.

### 5.7 Ensure a de-aired system

De-airing is another necessary step that ensures reliable and complaint free operation. For example, gurgling sounds are often caused by air in the system. There are several factors that are important for proper de-airing of heating system:

- Use a closed expansion vessel. If an open expansion vessel is used there is a high chance that air will continuously enter the water and thus be permanently supplied to the system, resulting in an increasing risk of corrosion.
- De-air by using hot water. Water at higher temperature dissolves less air. Thus, if de-airing is done only with cold water, air that was dissolved gets released again at working temperature.
- Avoid that the pump is working. If de-airing is performed while the pump is working it is less likely all the air will reach the highest points of the piping system. Therefore it is less likely all the air will be removed.



6. Products

In the previous two chapters you could read what and how to master in order to create high quality and energy efficient two-pipe heating systems. In this chapter you can find first-hand information and links to more detailed information about the products available to establish such systems.

6.1 Automatic balancing valves

These valves control the  $\Delta p$  on riser level as shown in the method 1 option. They consist of two individual products or can be bundled into a set.

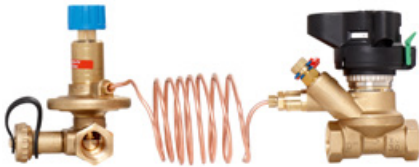

Typically they contain a differential pressure controller mounted in the return pipe of the riser. This controller is set to the required differential pressure in the riser and the connected radiators. It eliminates the pressure fluctuations in the built-in pressure controller. Via an impulse tube they are connected with a partner valve, mounted in the supply pipe of the riser. Although mostly not required, the partner valve can be used to limit the maximum riser flow.

YouTube

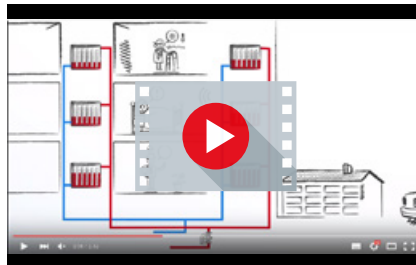

Here you can see an animation to show e.g. Housing Associations or other professional end-users about how it works and they will benefit.

> Danfoss offers the ASV automatic balancing valves

6.2 Thermostatic radiator valves

These valves control the required flow through a radiator in the method 1 option. To be able to set the required Kv value a version with pre-setting feature is required. Each radiator valve is pre-set to its required value. In combination with the riser mounted automatic balancing valves the entire system is hydraulically balanced.



YouTube



Here you can see an animation how it works.

> Danfoss offers the RA-N pre-setting radiator valves

### 6.3 Pressure independent radiator valves



These valves control the  $q_v$  on radiator level as shown in the method 2 option. They contain a built-in differential pressure controller as well as a flow limitation feature. By correctly commissioning all radiator valves in the system to their design flow, the entire system will automatically be balanced.

### YouTube

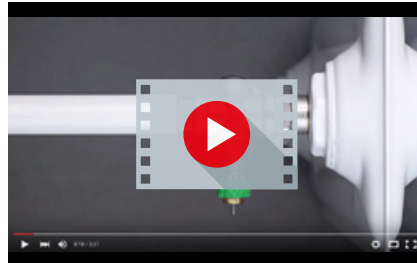

Here you can see an animation how it works.

> Danfoss offers the *Dynamic Valve™* pressure independent radiator valves

### 6.4 Thermostatic sensors



Thermostatic sensors are installed on either pre-setting thermostatic radiator valves (method 1) or pressure independent valves (method 2). The room temperature is automatically controlled as the radiators will be provided with less or more heated water depending the set and measured room temperature. Residents can determine their preferred temperature in each different room of their apartment.

> Danfoss offers RA series thermostatic sensors

### 6.5 Electronic sensors



These are an alternative for the thermostatic sensors. Time schedules with different room temperatures depending the time of the day can be selected or programmed. This offers the residents extra comfort and energy savings.

> Danfoss offers *living by Danfoss* electronic sensors

### 6.6 Speed controlled pumps



Speed controlled pumps provide the best conditions for a hydronic balanced system in both method 1 and 2. They constantly adapt the pump head capacity and flow to the actual heating system condition which optimizes the systems efficiency, improves the overall performance of the valves and minimizes the electricity costs.

### YouTube



Here you can see MAGNA3 introduction video.

> Grundfos offers ALPHA2 speed controlled pumps

> Grundfos offers MAGNA3 speed controlled pumps

**7. Energy saving expectations**

After a heating system has been renovated or created according to the described guidelines, in ideal circumstances up to 50% energy savings can be achieved.

**50% savings come from:**

- Applying automatic temperature control (e.g. TRV's) on each radiator (**up to 25%**)  
Minimize energy use by responding to internal and external heat load. The more stable the room temperature, the less energy is lost. The ability to control the room temperature results in a more efficient behavior from residents.
- Use of automatic balancing solutions to control water flows (**up to 20%**)  
The use of automatic balancing solutions lower the average building temperature. It also increases the efficiency of the heat source and reduces heat loss in transportation pipes. Weather compensated controllers that previously were set at higher temperature levels due to comfort problems now can be lowered, working more efficiently thanks to proper hydronic balancing.
- Use of speed controlled pumps (**up to 5%**)  
Although it seems that the use of speed controlled pumps just offer a small contribution to the total saving, it's actually an easy to implement solution that saves up to 70% ! compared to the amount of electricity used by traditional, fixed speed pumps. Besides that they ensure best working conditions for the other system components.

**7.1 Electric energy**

In heating systems most of the energy used is for primary energy production, being the heat from a boiler, district heating network or the alike. Systems having a poor hydronic balance result in significant over pumping, causing the pump to use more electric energy as would be needed in a hydronic balanced system. On average the pump energy consumption is about 6% of the total energy. In an optimal heating system though, a speed controlled pump reduces the average pump energy to a total of only 3%.

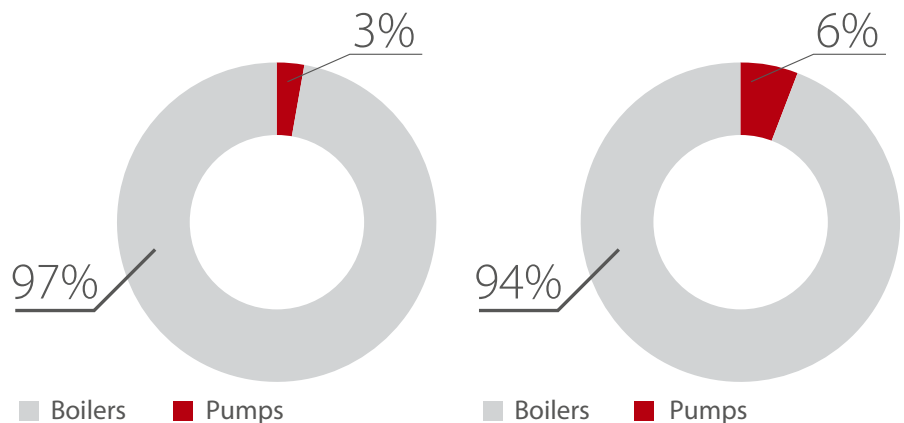

**7.2 Investment and payback time**

From investment point of view, it is interesting to consider payback time, in correspondence to type of renovation:

Renovation type	Estimated savings	Payback time
Insulation (walls and roof)	30-40%	+10 years
Room control	15-25 %	1,5 - 3 years
Automatic balancing	10-20 %	1 - 3 years
Speed controlled pump	30-55%	1 – 3 years

## 8. Conclusion

Achieving energy efficient and complaint free heating systems in buildings can be a challenge. Experience learns that in many buildings/systems a hydronic balance is not established. Hydronic imbalances are the root cause for high energy bills and resident complaints about the heating system.

Fortunately, solutions to solve the imbalances are available. Automatic hydronic balancing at the risers or directly at the radiators, speed controlled pumps with different setting options, a proper water quality and proper commissioning of the system secure optimized functionality and performance of the heating system. It benefits both building owners as well as building users or residents.

In addition to the above mentioned short term benefits investing in improved heating systems also allows the energy savings achieved to be invested into new, additional energy saving measures. In the long term our buildings will become more and more sustainable but it only makes sense to invest in sustainable energy systems after the efficiency of existing energy usage is secured. In the near future we will get to see many heating technology developments. No matter the innovation, all rely on a proper basis of well balanced and optimized water distribution.



# Case studies

To support the whitepaper with practical cases we collected a few case study documents for inspiration. You can click on the below mentioned studies to open a case story PDF document.

## Riser mounted automatic balancing case study:



➤ [CLICK TO READ](#)

## Radiator mounted automatic balancing case studies:



➤ [CLICK TO READ](#)



➤ [CLICK TO READ](#)

## Speed controlled pump case study:



➤ [CLICK TO READ](#)

# About

This whitepaper is prepared for you by heating specialists from Danfoss A/S and Grundfos A/S. Both are Danish companies with a long history in developing high quality products and solutions that achieve energy efficiency and increased comfort in heating systems. We hope the content in this whitepaper is supporting everybody involved in designing, commissioning and servicing two-pipe heating systems. In case you have any questions or comments about this whitepaper or the products and solutions mentioned feel free to contact your local Danfoss or Grundfos sales office.



**Danfoss A/S** · Heating Segment  
 Ulvehavevej 61 · 7100 Vejle · Denmark  
 Tel.: +45 7488 8500 · Email: [heating@danfoss.com](mailto:heating@danfoss.com) · [www.heating.danfoss.com](http://www.heating.danfoss.com)



**GRUNDFOS Holding A/S**  
 Poul Due Jensens Vej 7 · 8850 Bjerringbro · Denmark  
 Tel.: +45 8750 1400 · [www.grundfos.com](http://www.grundfos.com)

Danfoss can accept no responsibility for possible errors in catalogues, brochures and other printed material. Danfoss reserves the right to alter its products without notice. This also applies to products already on order provided that such alterations can be made without subsequential changes being necessary in specifications already agreed. All trademarks in this material are property of the respective companies. Danfoss and the Danfoss logotype are trademarks of Danfoss A/S. All rights reserved.