



Programming Guide

VLT[®] PROFINET MCA 120

VLT[®] Frequency Converter Series FC 102 • FC 103 • FC 202
FC 301/302 • FCD 302



Contents

1 Introduction	3
1.1 Purpose of the Manual	3
1.2 Additional Resources	3
1.3 Document and Software Version	3
1.4 Product Overview	3
1.5 Approvals and Certifications	4
1.6 Symbols, Abbreviations and Conventions	4
2 Safety	5
2.1 Safety Symbols	5
2.2 Qualified Personnel	5
2.3 Safety Precautions	5
3 Configuration	7
3.1 Configure the PROFINET Network	7
3.2 Configure the Controller	7
3.2.1 GSDML File	7
3.3 Configure the Frequency Converter	9
3.3.1 VLT Parameters	9
4 Control	10
4.1 PPO Types	10
4.2 PCV Parameter Access	11
4.3 Process Data	14
4.3.1 Process Control Data	14
4.3.2 Process Status Data	14
4.3.3 Reference Handling	15
4.3.4 Process Control Operation	15
4.3.5 Influence of the Digital Input Terminals upon FC Control Mode	16
4.4 Control Profile	16
4.5 PROFIdrive Control Profile	16
4.5.1 Control Word according to PROFIdrive Profile (CTW)	16
4.5.2 Status Word according to PROFIdrive Profile (STW)	17
4.5.3 PROFIdrive State Transition Diagram	19
4.6 FCdrive Control Profile	20
4.6.1 Control Word according to FC Profile (CTW)	20
4.6.2 Status Word according to FC Profile (STW)	21
5 Acyclic Communication (DP-V1)	23
5.1 Features of an IO Controller System	23

5.2 Features of an IO-Supervisor System	23
5.3 Addressing Scheme	24
5.4 Acyclic Read/Write Request Sequence	25
5.5 Data Structure in the Acyclic Telegrams	26
5.6 Header	26
5.7 Parameter Block	26
5.8 Data Block	26
6 Parameters	28
6.1 Parameter Group 0-** Operation/Display	28
6.2 Parameter Group 8-** Communication and Option	28
6.3 Parameter Group 9-** PROFIdrive	32
6.4 Parameter Group 12-** Ethernet	36
6.5 PROFINET-specific Parameters	39
6.6 Object and Data Types Supported	42
7 Application Examples	44
7.1 Example: Process Data with PPO Type 6	44
7.2 Example: Control Word Telegram using Standard Telegram 1/PPO3	45
7.3 Example: Status Word Telegram using Standard Telegram 1/PPO3	46
7.4 Example: PLC Programming	47
8 Troubleshooting	49
8.1 No Response to Control Signals	49
8.2 Warnings and Alarms	51
8.2.1 Warning and Alarm Messages	52
8.2.2 Alarm and Warning List	53
Index	57

1 Introduction

1.1 Purpose of the Manual

The VLT® PROFINET MCA 120 Programming Guide provides information about configuring the system, controlling the frequency converter, parameter access, programming, troubleshooting, as well as some typical application examples.

The programming guide is intended for use by qualified personnel who are familiar with the VLT® frequency converters, with PROFINET technology, and with the PC or PLC that is used as a master in the system.

Read the instructions before programming and follow the procedures in this manual.

VLT® is a registered trademark.

1.2 Additional Resources

Resources available for the frequency converters and optional equipment:

- The *VLT® Operating Instructions* provide the necessary information for getting the frequency converter up and running.
- The *VLT® Design Guide* provides detailed information about capabilities and functionality to design motor control systems.
- The *VLT® Programming Guide* provides greater detail on working with parameters and many application examples.
- The *VLT® PROFINET MCA 120 Installation Guide* provides information about installing the PROFINET and troubleshooting.
- The *VLT® PROFINET MCA 120 Programming Guide* provides information about configuring the system, controlling the frequency converter, parameter access, programming, troubleshooting, as well as some typical application examples.

Supplementary publications and manuals are available from Danfoss. See vlt-drives.danfoss.com/Support/Technical-Documentation/ for listings.

1.3 Document and Software Version

This manual is regularly reviewed and updated. All suggestions for improvement are welcome. *Table 1.1* shows the document version and the corresponding software version.

Edition	Remarks	Software version
MG90U1xx	1½ slot	1.xx
MG90U3xx	1 slot	2.00-2.11
MG92D1xx	1 slot	3.0x

Table 1.1 Document and Software Version

1.4 Product Overview

This programming guide relates to PROFINET interface ordering number 130B1135 (uncoated), ordering number 130B1235 (conformal coated), and to the FCD 302 PROFINET interface.

The PROFINET interface is designed to communicate with any system complying with the PROFINET schema version 2.2 and 2.3 standards.

Since the introduction in 2001, PROFINET has been updated to handle low and medium performance requirement supported by PROFINET RT up to high-end servo performance in PROFINET IRT. PROFINET is the Ethernet-based Fieldbus offering the most scalable and versatile technology today.

PROFINET provides the network tools to deploy standard Ethernet technology for manufacturing applications while enabling Internet and enterprise connectivity.

VLT® PROFINET MCA 120 is intended for use with:

- VLT® HVAC Drive FC 102
- VLT® Refrigeration Drive FC 103
- VLT® AQUA Drive FC 202
- VLT® AutomationDrive FC 301/302
- VLT® Decentral Drive FCD 302

Terminology

In this manual, several terms for Ethernet are used.

- *PROFINET*, is the term used to describe the PROFINET protocol.
- *Ethernet*, is a common term used to describe the physical layer of the network, and does not relate to the application protocol.

1.5 Approvals and Certifications



More approvals and certifications are available. For more information, contact a Danfoss local partner.

1.6 Symbols, Abbreviations and Conventions

Abbreviation	Definition
CC	Control card
CTW	Control word
DCP	Discovery and configuration protocol
DHCP	Dynamic host configuration protocol
EMC	Electromagnetic compatibility
I/O	Input/Output
IP	Internet protocol
IRT	Isochronous real time
LCP	Local control panel
LED	Light emitting diode
LSB	Least significant bit
MAV	Main actual value (actual speed)
MSB	Most significant bit
MRV	Main reference value
PC	Personal computer
PCD	Process control data
PLC	Programmable logic controller
PNU	Parameter number
PPO	Process parameter object
REF	Reference (=MRV)
RT	Real time
STW	Status word

Table 1.2 Symbols and Abbreviations

Conventions

Numbered lists indicate procedures.

Bullet lists indicate other information and description of illustrations.

Italicised text indicates

- cross reference
- link
- parameter name

2 Safety

2.1 Safety Symbols

The following symbols are used in this document:

⚠ WARNING

Indicates a potentially hazardous situation that could result in death or serious injury.

⚠ CAUTION

Indicates a potentially hazardous situation that could result in minor or moderate injury. It can also be used to alert against unsafe practices.

NOTICE

Indicates important information, including situations that can result in damage to equipment or property.

2.2 Qualified Personnel

Correct and reliable transport, storage, installation, operation, and maintenance are required for the trouble-free and safe operation of the frequency converter. Only qualified personnel are allowed to install or operate this equipment.

Qualified personnel are defined as trained staff, who are authorised to install, commission, and maintain equipment, systems, and circuits in accordance with pertinent laws and regulations. Additionally, the qualified personnel must be familiar with the instructions and safety measures described in this document.

2.3 Safety Precautions

⚠ WARNING

HIGH VOLTAGE

Frequency converters contain high voltage when connected to AC mains input, DC supply, or load sharing. Failure to perform installation, start-up, and maintenance by qualified personnel can result in death or serious injury.

- Installation, start-up, and maintenance must be performed by qualified personnel only.

⚠ WARNING

UNINTENDED START

When the frequency converter is connected to AC mains, DC power supply, or load sharing, the motor may start at any time. Unintended start during programming, service or repair work can result in death, serious injury, or property damage. The motor can start by means of an external switch, a serial bus command, an input reference signal from the LCP or LOP, via remote operation using MCT 10 software, or after a cleared fault condition.

To prevent unintended motor start:

- Disconnect the frequency converter from mains.
- Press [Off/Reset] on the LCP, before programming parameters.
- The frequency converter, motor, and any driven equipment must be fully wired and assembled when the frequency converter is connected to AC mains, DC power supply, or load sharing.

⚠ WARNING

DISCHARGE TIME

The frequency converter contains DC-link capacitors, which can remain charged even when the frequency converter is not powered. Failure to wait the specified time after power has been removed before performing service or repair work, can result in death or serious injury.

- Stop motor.
- Disconnect AC mains and remote DC-link power supplies, including battery back-ups, UPS, and DC-link connections to other frequency converters.
- Disconnect or lock PM motor.
- Wait for the capacitors to discharge fully, before performing any service or repair work. The duration of waiting time is specified in the relevant frequency converter operating instructions, *Chapter 2 Safety*.

⚠ WARNING**LEAKAGE CURRENT HAZARD**

Leakage currents exceed 3.5 mA. Failure to ground the frequency converter properly can result in death or serious injury.

- Ensure the correct grounding of the equipment by a certified electrical installer.

⚠ WARNING**EQUIPMENT HAZARD**

Contact with rotating shafts and electrical equipment can result in death or serious injury.

- Ensure that only trained and qualified personnel perform installation, start up, and maintenance.
- Ensure that electrical work conforms to national and local electrical codes.
- Follow the procedures in this document.

⚠ CAUTION**INTERNAL FAILURE HAZARD**

An internal failure in the frequency converter can result in serious injury, when the frequency converter is not properly closed.

- Ensure that all safety covers are in place and securely fastened before applying power.

3 Configuration

3.1 Configure the PROFINET Network

Ensure that all PROFINET devices connected to the same bus network have a unique station name (host name).

Set the PROFINET host name of the frequency converter via *12-08 Host Name*, or via hardware switches.

3.2 Configure the Controller

3.2.1 GSDML File

To configure a PROFINET controller, the configuration tool needs a GSDML file for each type of device on the network. The GSDML file is a PROFINET xml file containing the necessary communication setup data for a device. Download the GSDML file for the FC 102, , FC 202, FC 301/302, and FCD 302 frequency converters at www.danfoss.com/BusinessAreas/DrivesSolutions/profinet. The name of the GSDML file can vary compared to this manual. Download the latest version from the website. The following example shows an FC 302. The steps for FCD 302 and the other frequency converter series are the same.

Frequency converter series	Firmware version (15-61 Option SW Version)	GSDML file
FC 102 FC 202 FC 301/302	1.00-1.99	GSDML-V2.2-Danfoss-FC-20090620.xml
	2.00-2.15	GSDML-V2.3-Danfoss-FC-20131010.xml
	2.15	
FCD 302		GSDML-V2.2-Danfoss-FCD-20090620.xml
		GSDML-V2.3-Danfoss-FCD-20131010.xml

Table 3.1 GSDML file

The first step in configuration of the PROFINET controller is to import the GSDML file in the configuration tool. The following steps outlined show how to add a new GSDML file to the Simatic Manager software tool. For each frequency converter series, a GSDML file is typically imported once only, following the initial installation of the software tool.

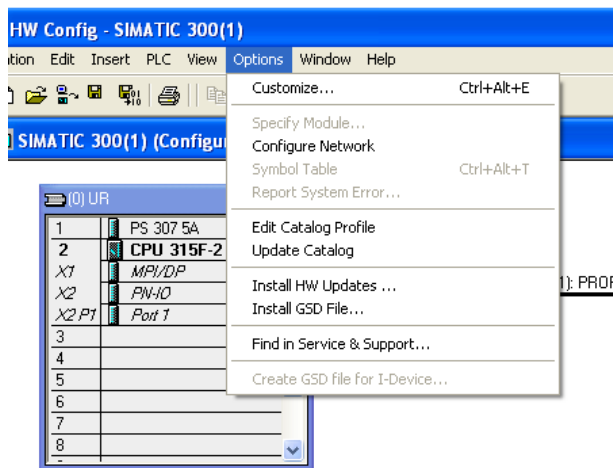

Illustration 3.1 Import the GSDML File in the Configuration Tool

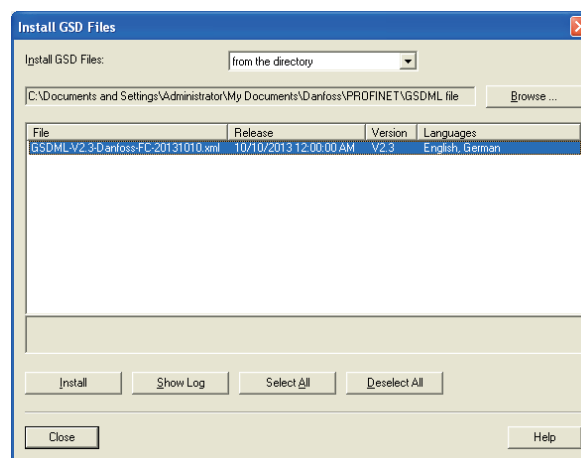
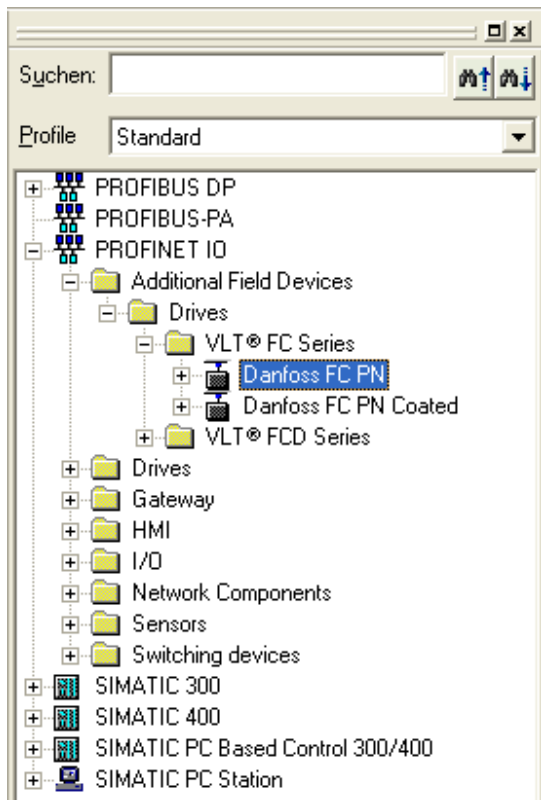

Illustration 3.2 Add a New GSDML File to the Simatic Manager Software Tool

The FC 102//FC 202/FC 301/FC 302/FCD 302 GSDML file is now imported and is accessible via the following path in the hardware catalogue:

3

3



130BE027.10

Illustration 3.3 Path in the Hardware Catalogue

Open a project, set up the hardware, and add a PROFINET Master system. Select Danfoss FC PN, then drag and drop it into the PROFINET IO system.

To enter the device name, open the properties for the inserted frequency converter. See *Illustration 3.4*.

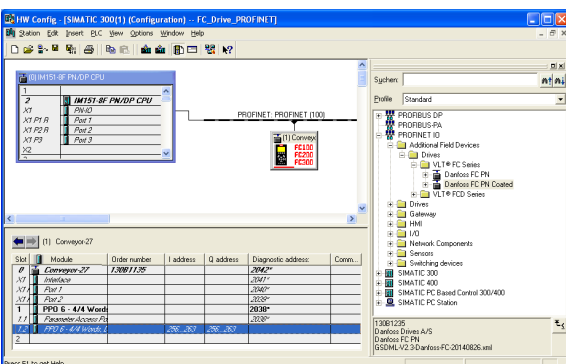

130BE030.10

Illustration 3.4 Open the Properties for the Inserted Frequency Converter to Enter the Device Name

NOTICE

The name must match the name in *12-08 Host Name*. If the check mark *Assign IP address via the IO controller* is set, the controller downloads the IP address to the IO device with the corresponding device name. The IP address is stored in the non-volatile memory of the frequency converters.

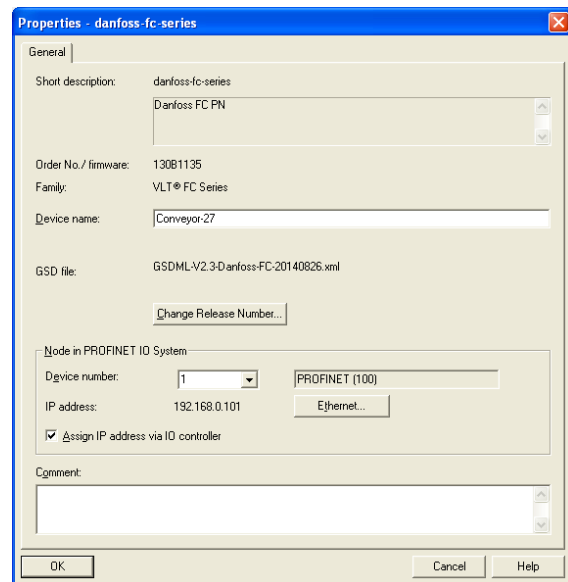

130BE028.10

Illustration 3.5 Set Up the Hardware and add a PROFINET Master System

The next step is to set up the peripheral input and output data. Data set up in the peripheral area is transmitted cyclically via telegrams/PPO types. In the example below, a PPO type 6 is dragged and dropped to slot 1.

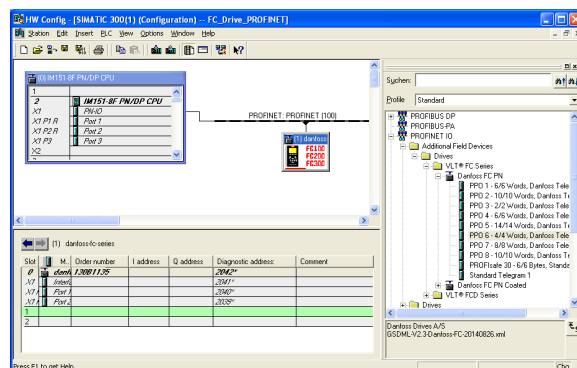

130BE029.10

Illustration 3.6 Set up the Peripheral Input and Output Data

The configuration tool automatically assigns addresses in the peripheral address area. In this example the input and output area have the following configuration:

PPO type 6

PCD word number	0	1	2	3
Input address	256–257	258–259	260–261	262–263
Set-up	STW	MAV	9-16 PCD Read Configuration	9-16 PCD Read Configuration

Table 3.2 PCD Read (VLT to PLC)

PCD word number	0	1	2	3
Output address	256–257	258–259	260–261	262–263
Set-up	CTW	MRV	9-15 PCD Write Configuration	9-15 PCD Write Configuration

Table 3.3 PCD Write (PLC to VLT)

Assign the PCDs via *9-16 PCD Read Configuration* for inputs and *9-15 PCD Write Configuration* for outputs.

Download the configuration file to the PLC. The PROFINET system starts data exchange when the PLC is set to *Run* mode.

3.3 Configure the Frequency Converter

3.3.1 VLT Parameters

The following parameters are important when configuring the frequency converter with a PROFINET interface.

- *0-40 [Hand on] Key on LCP*. If [Hand On] is activated, control of the frequency converter via the PROFINET interface is disabled.
- After an initial power-up, the frequency converter automatically detects whether a fieldbus option is installed in slot A, and sets *parameter 8-02 Control Word Source* to [Option A]. When an option is added, changed, or removed from an already commissioned frequency converter, it does not change *parameter 8-02 Control Word Source* but enters *Trip* mode, and the frequency converter displays an error
- *Parameter 8-10 Control Word Profile*. Select between the Danfoss frequency converter profile and the PROFIdrive profile
- *8-50 Coasting Select* to *8-56 Preset Reference Select*. Select how to gate PROFINET control commands with the digital input command of the control card.

NOTICE

When *8-01 Control Site* is set to [2] *Control word only*, then the settings in *Parameter 8-50 Coasting Select* to *Parameter 8-56 Preset Reference Select* is overruled, and only act on Bus-control.

4 Control

4

4.1 PPO Types

The PROFIBUS profile for frequency converters specifies a number of communication objects (parameter process data objects, PPO). The PROFIBUS profile for frequency converters is suitable for data exchange between a process controller (for example PLC) and a frequency converter. All PPOs are defined for cyclic data transfer (that is, DP V0), so that process data (PCD) and parameters (PCA) can be transferred from the master to the slave and vice versa.

Pure process data objects

PPO types 3, 4, 6, 7 and 8 are pure process data objects for applications requiring no cyclic parameter access. The PLC sends out process control data, and the frequency converter then responds with a PPO of the same length, containing process status data.

Illustration 4.1 shows the available PPO types:

- PCD 1: The first 2 bytes of the process data area (PCD 1) comprise a fixed part present in all PPO types.
- PCD 2: The next 2 bytes (PCD 2) are fixed for PCD write entries (see *9-15 PCD Write Configuration [1]*), but configurable for PCD read entries (see *9-16 PCD Read Configuration [1]*).
- PCD 3-10: In the remaining bytes, from PCD 3 and on, the process data can be parameterised with process signals, see *parameter 9-23 Parameters for Signals*.

The signals for transmission from the master to the frequency converter are determined by the setting in *9-15 PCD Write Configuration* (request from master to the frequency converter).

The signals for transmission from the frequency converter to the master (response from the frequency converter to master) are determined by the setting in *9-16 PCD Read Configuration*.

Parameter channel and process data

PPO types 1, 2, and 5 consist of a parameter channel and process data. Use the parameter channel for reading and/or updating of parameters (successively). Alternatively, for better utilisation of I/O and thus PLC capacity, access parameters via DP V1, by selecting a pure process data object (PPO type 3, 4, 6, 7, or 8).

Select the PPO type in the master configuration. The selection is automatically recorded in the frequency converter. No manual setting of PPO types in the frequency converter is required. Read the current PPO type in *parameter 9-22 Telegram Selection*. The setting *[1] Standard telegram 1* is equivalent to PPO type 3.

In addition, all PPO types can be set up as word-consistent or module-consistent. The process data area can be word or module consistent, whereas the parameter channel must always be module consistent.

- Word-consistent data is transmitted as individual, independent words between the PLC and the frequency converter.
- Module-consistent data is transmitted as sets of interrelated words transferred simultaneously between the PLC and the frequency converter.

Standard telegram



Danfoss telegram

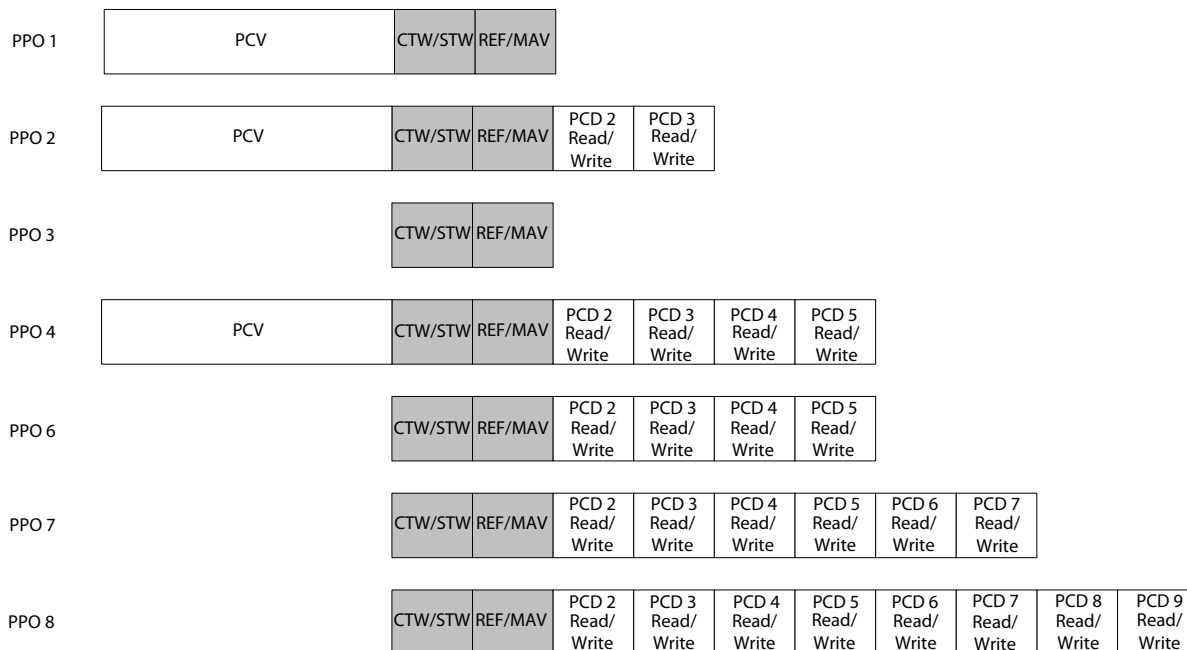

Illustration 4.1 Available PPO Types

4.2 PCV Parameter Access

The PROFINET cyclical data exchange performs parameter access via the PCV channel. The PCV channel forms part of the PPOs described in *chapter 4 Control*.

Use the PCV channel to read and write parameter values, and read status for descriptive attributes of each parameter.

4.2.1 PCA Handling

The PCA part of PPO types 1, 2, and 5 performs several tasks. Using PCA, the master controls and supervises parameters, and requests a response from the slave. Then the slave responds to a request from the master. *Requests and responses* is a handshake procedure and cannot be batched. Therefore, when the master sends out a read/write request, it must wait for the response before it sends a new request. The request or response data value is limited to maximum 4 bytes (see RC characteristics in *Table 4.1*), which implies that text strings are not transferable. For further information, see *chapter 7 Application Examples*.

4.2.2 PCA - Parameter Characteristics

15	14	13	12	11	10	9	8	7	6	5	4	3	2	1	0
RC				SMP	PNU										

Table 4.1 PCA - Parameter Characteristics

RC: Request/response characteristics (Range 0..15)

SMP: Spontaneous message (Not supported)

PNU : Parameter no. (Range 1..1999)

4.2.3 Request/Response Handling

The RC portion of the PCA word defines:

- The requests issued from the master to the slave.
- Other portions of the PCV involved:
 - PVA: The PVA portion transmits word-size parameter values in bytes 7 and 8, while long word size values require bytes 5–8 (32 bits).
 - IND: When the response/request contains array elements, the IND carries the array sub-index. When parameter descriptions are involved, the IND holds the record sub-index of the parameter description.

Response	Function
0	No response
1	Transfer parameter value (word)
2	Transfer parameter value (long word)
3	Transfer description element
4	Transfer parameter value (array word)
5	Transfer parameter value (array long word)
6	Transfer number of array elements
7	Request rejected (including fault number, see <i>Table 4.4</i>)
8	Not serviceable by PCV interface
9	Not used
10	Not used
11	Not used
12	Not used
13-15	Not used

Table 4.3 Response

4.2.4 RC Content

Request

The content of the RC portion of the PCA word for a request is listed in *Table 4.2*.

Request	Function
0	No request
1	Request parameter value
2	Change parameter value (word)
3	Change parameter value (long word)
4	Request description element
5	Change description element
6	Request parameter value (array)
7	Change parameter value (array word)
8	Change parameter value (array long word)
9	Request number of array elements
10-15	Not used

Table 4.2 Request

Response

When the slave rejects a request from the master, the RC word in the PPO-read indicates the rejection by assuming the value 7. Bytes 7 and 8 in the PVA element carry the fault number.

The content of the RC portion of the PCA word for a response is listed in *Table 4.3*.

Fault number	Interpretation
0	Illegal PNU
1	Parameter value cannot be changed.
2	Upper or lower limit exceeded.
3	Subindex corrupted.
4	No array
5	Data type false
6	Cannot be set by user (reset only).
7	Description element cannot be changed.
8	IR required PPO-write not available.
9	Description data not available.
10	Access group
11	No parameter write access
12	Key word missing.
13	Text in cyclical transmission not readable.
14	Name in cyclical transmission not readable.
15	Text array not available
16	PPO-write missing
17	Request temporarily rejected
18	Other fault
19	Data in cyclical transmission not readable.
130	There is no bus access to the parameter called.
131	Data change is not possible because factory set-up has been selected.

Table 4.4 Fault Numbers

4.2.5 Example

This example shows

- How to use PPO type 1 to change the ramp-up time to 10 s, in *3-41 Ramp 1 Ramp Up Time*.
- How to command a start and speed reference of 50%.

Frequency converter parameter settings:

8-50 Coasting Select: Bus

Parameter 8-10 Control Word Profile: PROFdrive profile

4.2.5.1 PCV

PCA parameter characteristics

PCA part (byte 1-2).

The RC part tells what the PCV part must be used for. The functions available are listed in *chapter 4.2.1 PCA Handling*.

When a parameter is changed, select value 2 or 3. In this example, 3 is selected, because *3-41 Ramp 1 Ramp Up Time* covers a long word (32 bits).

3-41 Ramp 1 Ramp Up Time=155 hex: In this example, byte 1 and 2 are set to 3155. See the values for bytes 1 and 2 in *Table 4.5*.

IND (bytes 3-4)

Used when reading/changing parameters with sub-index, for example *9-15 PCD Write Configuration*. In the example bytes 3 and 4 are set to 00 hex. See the values for bytes 3 and 4 in *Table 4.5*.

PVA (bytes 5-8)

The data value of *3-41 Ramp 1 Ramp Up Time* must be changed to 10.00 s. The value transmitted must be 1000, because the conversion index for *3-41 Ramp 1 Ramp Up Time* is 2. This means that the value received by the frequency converter is divided by 100, such that the frequency converter perceives 1000 as 10.00. Bytes 5-8=1000=03E8 hex. See *chapter 6.6 Object and Data Types Supported*. See the values for bytes 5-8 in *Table 4.5*.

4.2.5.2 PCD

Control word (CTW) according to PROFdrive profile:

Control words consist of 16 bits. The meaning of each bit is explained in *chapter 4.5.1 Control Word according to PROFdrive Profile (CTW)* and *chapter 4.5.2 Status Word according to PROFdrive Profile (STW)*. The following bit pattern sets all necessary start commands:

0000 0100 0111 1111=047F hex.*

0000 0100 0111 1110=047E hex.*

0000 0100 0111 1111=047F hex. These are the values for bytes 9 and 10 in *Table 4.5*.

Quick stop: 0000 0100 0110 1111=046F hex.

Stop: 0000 0100 0011 1111=043F hex.

NOTICE

* For restart after power up:

- Set bits 1 and 2 of the CTW to 1.
- Toggle bit 0 from 0 to 1.

4.2.6 MRV

MRV is the speed reference, with data format *Standardised value*. 0 hex=0% and 4000 hex=100%.

In the example, 2000 hex is used, corresponding to 50% of the maximum frequency in *3-03 Maximum Reference*. See the values for bytes 11 and 12 in *Table 4.5*.

The whole PPO therefore has the following values in hex:

		Byte	Value
PCV	PCA	1	31
	PCA	2	55
	IND	3	00
	IND	4	00
	PVA	5	00
	PVA	6	00
	PVA	7	03
	PVA	8	E8
PCD	CTW	9	04
	CTW	10	7F
	MRV	11	20
	MVR	12	00

Table 4.5 Request Example: PPO Values in Hex

The process data within the PCD part acts immediately upon the frequency converter, and can be updated from the master as quickly as possible. The PCV part is a handshake procedure, which means that the frequency converter has to acknowledge the command, before a new one can be written.

Table 4.5 shows a positive response to the request example from *Table 4.5*.

		Byte	Value
PCV	PCA	1	21
	PCA	2	55
	IND	3	00
	IND	4	00
	PVA	5	00
	PVA	6	00
	PVA	7	03
	PVA	8	E8
PCD	STW	9	0F
	STW	10	07
	MAV	11	20
	MAR	12	00

Table 4.6 Response Example: Positive Response

The PCD part responds according to the state and parameterisation of the frequency converter.

PCV part response:

- PCA: As the request telegram, but here the RC part is taken from Table 4.3. In this example, RC is 2 hex, which is a confirmation that a parameter value of the type long word (32 bit) has been transferred. IND is not used in this example.
- PVA: 03E8 hex in the PVA part tells that the value of 3-41 Ramp 1 Ramp Up Time is 1000, which corresponds to 10.00.
- STW: 0F07 hex means that the motor is running and there are no warnings or faults.
- MAV: 2000 hex indicates that the output frequency is 50% of the maximum reference.

Table 4.7 shows a negative response to the request example from Table 4.5.

		Byte	Value
PCV	PCA	1	70
	PCA	2	00
	IND	3	00
	IND	4	00
	PVA	5	00
	PVA	6	00
	PVA	7	00
	PVA	8	02
PCD	STW	9	0F
	STW	10	07
	MAV	11	20
	MAR	12	00

Table 4.7 Response Example: Negative Response

RC is 7 hex, which means that the request has been rejected, and the fault number can be found in the PVA part.

In this case, the fault number is 2, which means that the upper or lower limit of the parameter is exceeded, see Table 4.4.

4.3 Process Data

Use the process data part of the PPO to control and monitor the frequency converter via the PROFIBUS.

4.3.1 Process Control Data

Process control data (PCD) is the process data sent from the PLC to the frequency converter.

Master/slave				
1	2	3	10
CTW	MRV	PCD	PCD
PCD write				

Table 4.8 Process Control Data

PCD 1 contains a 16-bit control word, and each bit controls a specific function of the frequency converter, see chapter 4.4 Control Profile.

PCD 2 contains a 16-bit speed setpoint in percentage format. See chapter 4.3.3 Reference Handling.

The content of PCD 3 to PCD 10 is determined by the settings in 9-15 PCD Write Configuration and 9-16 PCD Read Configuration.

4.3.2 Process Status Data

Process status data is the process data sent from the frequency converter, and contains information about the current state.

Slave/master				
1	2	3	10
STW	MAV	PCD	PCD
PCD read				

Table 4.9 Process Status Data

PCD 1 contains a 16-bit status word, and each bit contains information regarding a possible state of the frequency converter.

PCD 2 contains per default the value of the current speed of the frequency converter in percentage format (see chapter 4.3.3 Reference Handling). PCD 2 can be configured to contain other process signals.

The content of PCD 3 to PCD 10 is determined by the settings in 9-16 PCD Read Configuration.

4.3.3 Reference Handling

The reference handling is an advanced mechanism that sums up references from different sources, as shown in *Illustration 4.2*.

For more information on reference handling, refer to the design guide of the relevant frequency converter.

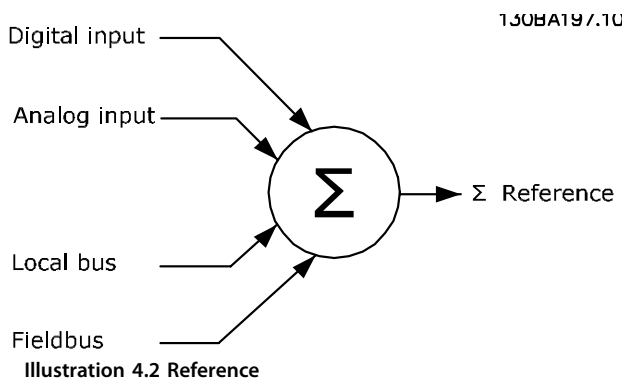

The reference, or speed setpoint, is sent via PROFIBUS and is always transmitted to the frequency converter in percentage format as integers represented in hexadecimal (0-4000 hex).

The reference (MRV) and feedback (MAV) are always scaled equally. The setting of *3-00 Reference Range* determines the scaling of the reference and feedback (MAV), see *Illustration 4.3*.

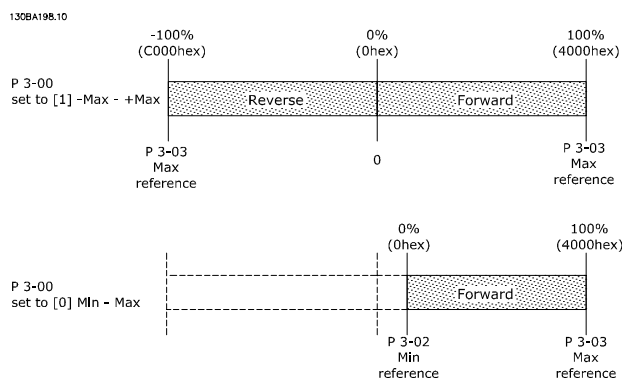

Illustration 4.3 Reference (MRV) and Feedback (MAV), Scaled

NOTICE

When *3-00 Reference Range* is set to *[0] Min - Max*, a negative reference is handled as 0%.

The actual output of the frequency converter is limited by the speed limit parameters *Motor Low/High Speed Limit [RPM/Hz]* in *4-11 Motor Speed Low Limit [RPM]* to *4-14 Motor Speed High Limit [Hz]*.

The final speed limit is set in *4-19 Max Output Frequency*.

Table 4.10 lists the reference (MRV) and the feedback (MAV) formats.

MRV/MAV	Integer in hex	Integer in decimal
100%	4000	16,384
75%	3000	12,288
50%	2000	8,192
25%	1000	4,096
0%	0	0
-25%	F000	-4,096
-50%	E000	-8,192
-75%	D000	-12,288
-100%	C000	-16,384

Table 4.10 Reference/Feedback (MRV/MAV) Format

NOTICE

Negative numbers are formed as complement of 2.

NOTICE

The data type for MRV and MAV is an N2 16-bit standardised value, expressing a range from -200% to +200% (8001 to 7FFF).

Example

The following settings determine the speed, as shown in *Table 4.11*:

- *1-00 Configuration Mode* set to *[0] Speed open loop*.
- *3-00 Reference Range* set to *[0] Min-Max*.
- *3-02 Minimum Reference* set to 100 RPM.
- *3-03 Maximum Reference* set to 3000 RPM.

MRV/MAV	Actual speed [RPM]
0%	100
25%	825
50%	1550
75%	2275
100%	3000

Table 4.11 Actual Speed for MRV/MAV

4.3.4 Process Control Operation

In process control operation, *1-00 Configuration Mode* is set to *[3] Process*.

The reference range in *3-00 Reference Range* is always *[0] Min - Max*.

- MRV represents the process setpoint.
- MAV expresses the actual process feedback (range ±200%).

4.3.5 Influence of the Digital Input Terminals upon FC Control Mode

Set the influence of the digital input terminals upon control of the frequency converter in *8-50 Coasting Select* to *8-56 Preset Reference Select*.

NOTICE

The setting of *8-01 Control Site* overrules the settings in *8-50 Coasting Select* to *8-56 Preset Reference Select*. The setting of terminal *37 Coast stop (safe)* overrules any other parameter.

Each of the digital input signals can be programmed to logic AND, logic OR, or to have no relation to the corresponding bit in the control word. In this way the following signal sources initiate a specific control command, for example stop/coast:

- Fieldbus only,
- Fieldbus AND digital input, or
- Either fieldbus OR digital input terminal.

CAUTION

To control the frequency converter via PROFIBUS, set *8-50 Coasting Select* to either [1] *Bus* or to [2] *Logic AND*, and set *8-01 Control Site* to [0] or [2].

For more detailed information and examples of logical relationship options, see *chapter 8 Troubleshooting*.

4.4 Control Profile

Control the frequency converter according to

- the PROFIdrive profile, see *chapter 4.5 PROFIdrive Control Profile*, or
- the Danfoss FC control profile, see *chapter 4.6 FCDrive Control Profile*.

Select the desired control profile in *parameter 8-10 Control Word Profile*. The choice of profile affects the control word and status word only.

chapter 4.5 PROFIdrive Control Profile and *chapter 4.6 FCDrive Control Profile* provide a detailed description of control and status data.

4.5 PROFIdrive Control Profile

This section describes the functionality of the control word and status word in the PROFIdrive profile.

4.5.1 Control Word according to PROFIdrive Profile (CTW)

The control word is used to send commands from a master (e.g. a PC) to a slave.

Bit	Bit=0	Bit=1
00	OFF 1	ON 1
01	OFF 2	ON 2
02	OFF 3	ON 3
03	Coasting	No coasting
04	Quick stop	Ramp
05	Hold frequency output	Use ramp
06	Ramp stop	Start
07	No function	Reset
08	Jog 1 OFF	Jog 1 ON
09	Jog 2 OFF	Jog 2 ON
10	Data invalid	Data valid
11	No function	Slow down
12	No function	Catch up
13	Parameter set-up	Selection lsb
14	Parameter set-up	Selection msb
15	No function	Reverse

Table 4.12 Control Word Bits

Explanation of the control bits

Bit 00, OFF 1/ON 1

Normal ramp stops using the ramp times of the actual selected ramp.

Bit 00="0" leads to the stop and activation of the output relay 1 or 2 if the output frequency is 0 Hz and if [Relay 123] has been selected in *5-40 Function Relay*.

When bit 0="1", the frequency converter is in State 1: *Switching on inhibited*.

Refer to *Illustration 4.4*.

Bit 01, OFF 2/ON 2

Coasting stop.

When bit 01="0", a coasting stop and activation of the output relay 1 or 2 occurs if the output frequency is 0 Hz and if [Relay 123] has been selected in *5-40 Function Relay*.

When bit 01="1", the frequency converter is in State 1: *Switching on inhibited*. Refer to *Illustration 4.4*.

Bit 02, OFF 3/ON 3

Quick stop using the ramp time of *3-81 Quick Stop Ramp Time*.

When bit 02="0", a quick stop and activation of the output relay 1 or 2 occurs if the output frequency is 0 Hz and if [Relay 123] has been selected in *5-40 Function Relay*.

When bit 02="1", the frequency converter is in State 1: *Switching on inhibited*.

Refer to *Illustration 4.4*.

Bit 03, Coasting/no coasting

Coasting stop Bit 03="0" leads to a stop.

When bit 03="1", the frequency converter can start if the other start conditions are fulfilled.

NOTICE

The selection in *8-50 Coasting Select* determines how bit 03 is linked with the corresponding function of the digital inputs.

Bit 04, Quick stop/ramp

Quick stop using the ramp time of *3-81 Quick Stop Ramp Time*.

When bit 04="0", a quick stop occurs.

When bit 04="1", the frequency converter can start if the other start conditions are fulfilled.

NOTICE

The selection in *parameter 8-51 Quick Stop Select* determines how bit 04 is linked with the corresponding function of the digital inputs.

Bit 05, Hold frequency output/use ramp

When bit 05="0", the current output frequency is being maintained even if the reference value is modified.

When bit 05="1", the frequency converter can perform its regulating function again; operation occurs according to the respective reference value.

Bit 06, Ramp stop/start

Normal ramp stop using the ramp times of the actual ramp selected. In addition, if relay 123 is selected in *5-40 Function Relay*, and if the output frequency is 0 Hz, this bit activates output relays 01 or 04. Bit 06="0" leads to a stop. When bit 06="1", the frequency converter can start if the other start conditions are fulfilled.

NOTICE

The selection in *8-53 Start Select* determines how bit 06 is linked with the corresponding function of the digital inputs.

Bit 07, No function/reset

Reset after switching off. Acknowledges event in fault buffer.

When bit 07="0", no reset occurs.

When there is a slope change of bit 07 to "1", a reset occurs after switching off.

Bit 08, Jog 1 OFF/ON

Activation of the pre-programmed speed in *8-90 Bus Jog 1 Speed*. JOG 1 is only possible if bit 04="0" and bits 00-03="1".

Bit 09, Jog 2 OFF/ON

Activation of the pre-programmed speed in *8-91 Bus Jog 2 Speed*. JOG 2 is only possible if bit 04="0" and bits 00-03="1".

Bit 10, Data invalid/valid

Used to tell the frequency converter whether the control word is to be used or ignored. Bit 10="0" causes the control word to be ignored, giving the opportunity to turn off the control word when updating/reading parameters.

Bit 10="1" causes the control word to be used. This function is relevant, because the control word is always contained in the telegram, regardless of which type of telegram is used.

Bit 11, No function/slow down

Used to reduce the speed reference value by the amount given in *3-12 Catch up/slow Down Value* value.

When bit 11="0", no modification of the reference value occurs.

When bit 11="1", the reference value is reduced.

Bit 12, No function/catch up

Used to increase the speed reference value by the amount given in *3-12 Catch up/slow Down Value*.

When bit 12="0", no modification of the reference value occurs.

When bit 12="1", the reference value is increased.

If both slowing down and accelerating are activated (bit 11 and 12="1"), slowing down has priority, and the speed reference value is reduced.

Bits 13/14, Set-up selection

Bits 13 and 14 are used to select between the 4 parameter set-ups according to *Table 4.13*.

The function is only possible if *Multi Set-up* has been selected in *0-10 Active Set-up*. The selection in *8-55 Set-up Select* determines how bits 13 and 14 are linked with the corresponding function of the digital inputs. Changing set-up while running is only possible if the set-ups have been linked in *0-12 This Set-up Linked to*.

Set-up	Bit 13	Bit 14
1	0	0
2	1	0
3	0	1
4	1	1

Table 4.13 Parameter Set-ups

Bit 15, No function/reverse

Bit 15=0 causes no reversing.

Bit 15=1 causes reversing.

NOTICE

In the factory setting, reversing is set to *digital* in *parameter 8-54 Reversing Select*.

NOTICE

Bit 15 causes reversing only when *Ser. communication, Logic or, or Logic and* is selected.

4.5.2 Status Word according to PROFIdrive Profile (STW)

The status word is used to notify a master (for example a PC) about the status of a slave.

Bit	Bit=0	Bit=1
00	Control not ready	Control ready
01	Drive not ready	Drive ready
02	Coasting	Enable
03	No error	Trip
04	OFF 2	ON 2
05	OFF 3	ON 3
06	Start possible	Start not possible
07	No warning	Warning
08	Speed ≠ reference	Speed = reference
09	Local operation	Bus control
10	Out of frequency limit	Frequency limit ok
11	No operation	In operation
12	Drive OK	Stopped, autostart
13	Voltage OK	Voltage exceeded
14	Torque OK	Torque exceeded
15	Timer OK	Timer exceeded

Table 4.14 Status Word Bits
Explanation of the status bits
Bit 00, Control not ready/ready

When bit 00="0", bit 00, 01 or 02 of the control word is "0" (OFF 1, OFF 2 or OFF 3) - or the frequency converter is switched off (trip).

When bit 00="1", the frequency converter control is ready, but there is not necessarily power supply to the unit present (in the event of external 24 V supply of the control system).

Bit 01, VLT not ready/ready

Same significance as bit 00, however, there is a supply of the power unit. The frequency converter is ready when it receives the necessary start signals.

Bit 02, Coasting/enable

When bit 02="0", bit 00, 01 or 02 of the control word is "0" (OFF 1, OFF 2 or OFF 3 or coasting) - or the frequency converter is switched off (trip).

When bit 02="1", bit 00, 01 or 02 of the control word is "1"; the frequency converter has not tripped.

Bit 03, No error/trip

When bit 03="0", no error condition of the frequency converter exists.

When bit 03="1", the frequency converter has tripped and requires a reset signal before it can start.

Bit 04, ON 2/OFF 2

When bit 01 of the control word is "0", bit 04="0".

When bit 01 of the control word is "1", bit 04="1".

Bit 05, ON 3/OFF 3

When bit 02 of the control word is "0", bit 05="0".

When bit 02 of the control word is "1", bit 05="1".

Bit 06, Start possible/start not possible

If PROFIdrive has been selected in *parameter 8-10 Control Word Profile*, bit 06 is "1" after a switch-off acknowledgment, after activation of OFF2 or OFF3, and after switching on the mains voltage. *Start not possible* is reset,

with bit 00 of the control word being set to "0" and bit 01, 02 and 10 being set to "1".

Bit 07, No warning/warning

Bit 07="0" means that there are no warnings.

Bit 07="1" means that a warning has occurred.

Bit 08, Speed≠reference/speed=reference

When bit 08="0", the current speed of the motor deviates from the set speed reference value. This may occur, for example, when the speed is being changed during start/stop through ramp up/down.

When bit 08="1", the current speed of the motor corresponds to the set speed reference value.

Bit 09, Local operation/bus control

Bit 09="0" indicates that the frequency converter has been stopped with *[Stop]* on the LCP, or that *[Linked to hand]* or *[Local]* has been selected in *3-13 Reference Site*.

When bit 09="1", the frequency converter can be controlled through the serial interface.

Bit 10, Out of frequency limit/frequency limit OK

When bit 10="0", the output frequency is outside the limits set in *4-52 Warning Speed Low* and *4-53 Warning Speed High*.

When bit 10="1", the output frequency is within the indicated limits.

Bit 11, No operation/operation

When bit 11="0", the motor does not turn.

When bit 11="1", the frequency converter has a start signal, or the output frequency is higher than 0 Hz.

Bit 12, Drive OK/Stopped, autostart

When bit 12="0", there is no temporary overloading of the inverter.

When bit 12="1", the frequency converter has stopped due to overloading. However, the frequency converter has not switched off (tripped) and starts again after the overloading has ended.

Bit 13, Voltage OK/voltage exceeded

When bit 13="0", the voltage limits of the frequency converter are not exceeded.

When bit 13="1", the direct voltage in the intermediate circuit of the frequency converter is too low or too high.

Bit 14, Torque OK/torque exceeded

When bit 14="0", the motor torque is below the limit selected in *4-16 Torque Limit Motor Mode* and *4-17 Torque Limit Generator Mode*.

When bit 14="1", the limit selected in *4-16 Torque Limit Motor Mode* or *4-17 Torque Limit Generator Mode* is exceeded.

Bit 15, Timer OK/timer exceeded

When bit 15="0", the timers for the thermal motor protection and thermal frequency converter protection have not exceeded 100%.

When bit 15="1", 1 of the timers has exceeded 100%.

4.5.3 PROFdrive State Transition Diagram

In the PROFdrive control profile, the control bits:

- 0-3 perform the basic start-up/power down functions.
- 4-15 perform application-oriented control.

Illustration 4.4 shows the basic state transition diagram, where control bits 0-3 control the transitions, and the corresponding status bit indicates the actual state. The black bullets indicate the priority of the control signals, where fewer bullets indicate lower priority, and more bullets indicate higher priority.

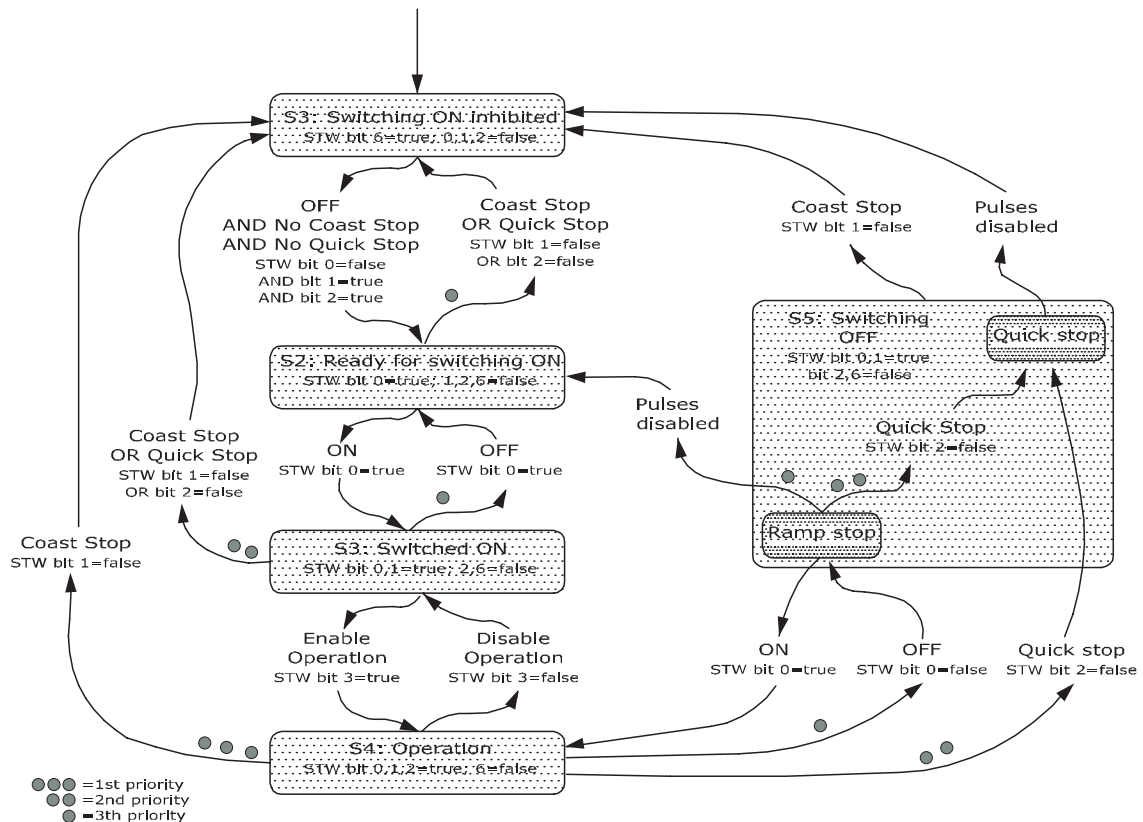

1308D806.10

Illustration 4.4 PROFdrive State Transition Diagram

4.6 FCDrive Control Profile

4.6.1 Control Word according to FC Profile (CTW)

To select Danfoss FC protocol in the control word, set *parameter 8-10 Control Word Profile* to [0] *Frequency converter profile*. Use the control word to send commands from a master (PLC or PC) to a slave (frequency converter).

Bit	Bit value=0	Bit value=1
00	Reference value	External selection lsb
01	Reference value	External selection msb
02	DC brake	Ramp
03	Coasting	No coasting
04	Quick stop	Ramp
05	Hold output frequency	Use ramp
06	Ramp stop	Start
07	No function	Reset
08	No function	Jog
09	Ramp 1	Ramp 2
10	Data invalid	Data valid
11	No function	Relay 01 active
12	No function	Relay 04 active
13	Parameter set-up	selection lsb
14	Parameter set-up	selection msb
15	No function	Reverse

Table 4.15 Bit Values for FC Control Word

Explanation of the control bits

Bits 00/01 Reference value

Bits 00 and 01 are used to select between the 4 reference values, which are pre-programmed in *3-10 Preset Reference* according to *Table 4.16*.

NOTICE

In *8-56 Preset Reference Select* a selection is made to define how bit 00/01 gates with the corresponding function on the digital inputs.

Bit 01	Bit 00	Programmed ref. value	Parameter
0	0	1	[0] <i>3-10 Preset Reference</i>
0	1	2	[1] <i>3-10 Preset Reference</i>
1	0	3	[2] <i>3-10 Preset Reference</i>
1	1	4	[3] <i>3-10 Preset Reference</i>

Table 4.16 Programmed Reference Values for Bits

Bit 02, DC brake

Bit 02="0" - leads to DC braking and stop. Braking current and duration are set in *2-01 DC Brake Current* and *2-02 DC Braking Time*.

Bit 02="1" - leads to ramping.

Bit 03, Coasting

Bit 03="0" - causes the frequency converter immediately to coast the motor to a standstill.

Bit 03="1" - enables the frequency converter to start the motor if the other starting conditions have been fulfilled.

NOTICE

In *8-50 Coasting Select* a selection is made to define how bit 03 gates with the corresponding function on a digital input.

Bit 04, Quick stop

Bit 04="0" - causes a quick stop, ramping the motor speed down to stop via *3-81 Quick Stop Ramp Time*.

Bit 04="1" - the frequency converter ramps the motor speed down to stop via *3-42 Ramp 1 Ramp Down Time* or *3-52 Ramp 2 Ramp Down Time*.

Bit 05, Hold output frequency

Bit 05="0" - causes the present output frequency (in Hz) to freeze. The frozen output frequency can only be changed with the digital inputs (*5-10 Terminal 18 Digital Input* to *5-15 Terminal 33 Digital Input*) programmed to *Speed up* and *Speed down*.

Bit 05="1" - uses ramp.

NOTICE

If *Freeze output* is active, stop the frequency converter with

- Bit 03 Coasting stop.
- Bit 02 DC braking.
- Digital input (*5-10 Terminal 18 Digital Input* to *5-15 Terminal 33 Digital Input*) programmed to *DC braking, Coasting stop, or Reset and coasting stop*.

Bit 06, Ramp stop/start

Bit 06="0" - causes a stop in which the motor speed is ramped down to stop via the selected *ramp down* parameter.

Bit 06="1" - permits the frequency converter to start the motor, if the other starting conditions have been fulfilled.

NOTICE

In *8-53 Start Select*, define how bit 06 Ramp stop/start gates with the corresponding function on a digital input.

Bit 07, Reset

Bit 07="0" - does not cause a reset.

Bit 07="1" - causes the reset of a trip. Reset is activated on the signal's leading edge, that is, when changing from logic "0" to logic "1".

Bit 08, Jog

Bit 08="0" - no function.

Bit 08="1" - *3-19 Jog Speed [RPM]* determines the output frequency.

Bit 09, Selection of ramp 1/2

Bit 09="0" - ramp 1 is active (3-40 Ramp 1 Type to 3-47 Ramp 1 S-ramp Ratio at Decel. Start).

Bit 09="1" - ramp 2 (3-50 Ramp 2 Type to 3-57 Ramp 2 S-ramp Ratio at Decel. Start) is active.

Bit 10, Data not valid/data valid

Tells the frequency converter whether it should use or ignore the control word.

Bit 10="0" - the control word is ignored.

Bit 10="1" - the control word is used. This function is relevant, because the control word is always contained in the telegram, regardless of which type of telegram is used. Thus, it is possible to turn off the control word, if it is not wished to use it when updating or reading parameters.

Bit 11, Relay 01

Bit 11="0" - relay 01 not activated.

Bit 11="1" - relay 01 activated, provided control word bit 11 has been selected in 5-40 Function Relay.

Bit 12, Relay 04

Bit 12="0" - relay 04 has not been activated.

Bit 12="1" - relay 04 has been activated, provided Control word bit 12 has been selected in 5-40 Function Relay.

Bit 13/14, Selection of set-up

Bits 13 and 14 are used to select from the 4 menu set-ups according to Table 4.17:

The function is only possible when Multi-Set-ups is selected in 0-10 Active Set-up.

Set-up	Bit 14	Bit 13
1	0	0
2	0	1
3	1	0
4	1	1

Table 4.17 Selection of Set-up

NOTICE

In 8-55 Set-up Select, define how bit 13/14 gates with the corresponding function on the digital inputs.

Bit 15 Reverse

Bit 15="0" - no reversing.

Bit 15="1" - reversing.

4.6.2 Status Word according to FC Profile (STW)

The status word is used to inform the master (for example a PC) of the operation mode of the slave (frequency converter).

Refer to chapter 7 Application Examples for an example of a status word telegram using PPO type 3.

Bit	Bit=0	Bit=1
00	Control not ready	Control ready
01	Frequency converter not ready	Frequency converter ready
02	Coasting	Enable
03	No error	Trip
04	No error	Error (no trip)
05	Reserved	-
06	No error	Triplock
07	No warning	Warning
08	Speed reference	Speed=reference
09	Local operation	Bus control
10	Out of frequency limit	Frequency limit ok
11	No operation	In operation
12	Frequency converter OK	Stopped, autostart
13	Voltage OK	Voltage exceeded
14	Torque OK	Torque exceeded
15	Timer OK	Timer exceeded

Table 4.18 Definition of Status Bits

Explanation of the status bits

Bit 00, Control not ready/ready

Bit 00="0" - the frequency converter has tripped.

Bit 00="1" - the frequency converter controls are ready, but the power component is not necessarily receiving any power supply (in case of 24 V external supply to controls).

Bit 01, frequency converter ready

Bit 01="0" - the frequency converter is not ready for operation.

Bit 01="1" - the frequency converter is ready for operation, but there is an active coasting command via the digital inputs or via serial communication.

Bit 02, Coasting stop

Bit 02="0" - the frequency converter has released the motor.

Bit 02="1" - the frequency converter can start the motor when a start command is given.

Bit 03, No error/trip

Bit 03="0" - the frequency converter is not in fault mode.

Bit 03="1" - the frequency converter is tripped, and that a reset signal is required to re-establish operation.

Bit 04, No error/error (no trip)

Bit 04="0" - the frequency converter is not in fault mode.

Bit 04="1" - there is a frequency converter error but no trip.

Bit 05, Not used

Bit 05 is not used in the status word.

Bit 06, No error/triplock

Bit 06="0" - the frequency converter is not in fault mode.

Bit 06="1" - the frequency converter is tripped, and locked.

Bit 07, No warning/warning

Bit 07="0" - there are no warnings.

Bit 07="1" - a warning has occurred.

Bit 08, Speed reference/speed = reference

Bit 08="0" - the motor runs, but the present speed is different from the preset speed reference. It could, for example, be the case while the speed ramps up/down during start/stop.

Bit 08="1" - the present motor speed matches the preset speed reference.

Bit 09, Local operation/bus control

Bit 09="0" - [Stop/Reset] is pressed on the LCP, or *Local control* in 3-13 *Reference Site* is selected. It is not possible to control the frequency converter via serial communication.

Bit 09="1" - it is possible to control the frequency converter via the fieldbus/serial communication.

Bit 10, Out of frequency limit

Bit 10="0" - the output frequency has reached the value in 4-11 *Motor Speed Low Limit [RPM]* or 4-13 *Motor Speed High Limit [RPM]*.

Bit 10="1" - the output frequency is within the defined limits.

Bit 11, No operation/in operation

Bit 11="0" - the motor is not running.

Bit 11="1" - the frequency converter has a start signal or the output frequency is higher than 0 Hz.

Bit 12, frequency converter OK/stopped, auto start

Bit 12="0" - there is no temporary over-temperature on the frequency converter.

Bit 12="1" - the frequency converter has stopped because of over-temperature, but the frequency converter has not tripped and resumes operation once the over-temperature stops.

Bit 13, Voltage OK/limit exceeded

Bit 13="0" - there are no voltage warnings.

Bit 13="1" - the DC voltage in the frequency converters intermediate circuit is too low or too high.

Bit 14, Torque OK/limit exceeded

Bit 14="0" - the motor current is lower than the torque limit selected in 4-16 *Torque Limit Motor Mode* or 4-17 *Torque Limit Generator Mode*.

Bit 14="1" - the torque limits in 4-16 *Torque Limit Motor Mode* and 4-17 *Torque Limit Generator Mode* are exceeded.

Bit 15, Timer OK/limit exceeded

Bit 15="0" - the timers for motor thermal protection and frequency converter thermal protection, have not exceeded 100%.

Bit 15="1" - 1 of the timers has exceeded 100%.

5 Acyclic Communication (DP-V1)

PROFINET offers more to the cyclical data communication, a cyclical communication. This feature is possible by an IO controller (for example, PLC), as well as an IO Supervisor (for example, PC Tool).

Cyclical communication means that data transfer takes place all the time with a certain update rate. This function is the known function normally used for quick update of I/O process data. Acyclic communication means a one-time event, used mainly for read/write on parameters from process controllers, PC-based tools, or monitoring systems.

5.1 Features of an IO Controller System

Cyclic data exchange.

Acyclic read/write on parameters.

The acyclic connection is fixed and cannot be changed during operation.

In general, an IO controller is used as process controller, responsible for commands, speed reference, status of the application, and so on (PLC or PC-based controller).

In the IO controller, acyclic connection can be used for general parameter access in the slaves.

5.2 Features of an IO-Supervisor System

Initiate/abort acyclic connection.

Acyclic read/write on parameters.

The acyclic connection can be established dynamically (initiated) or removed (aborted) even though an IO controller is active on the network.

The acyclic connection is typically used for configuration or commissioning tools for easy access to each parameter in any slave in the system.

5.3 Addressing Scheme

The structure of a PROFINET IO device is shown in *Illustration 5.1*.

An IO device consists of a number of physical or virtual slots. Slot 0 is always present, and represents the basic unit. Each slot contains a number of data blocks addressed by an index.

The master must address a variable in the slave as follows: /Slave address/Slot #/Index #

5

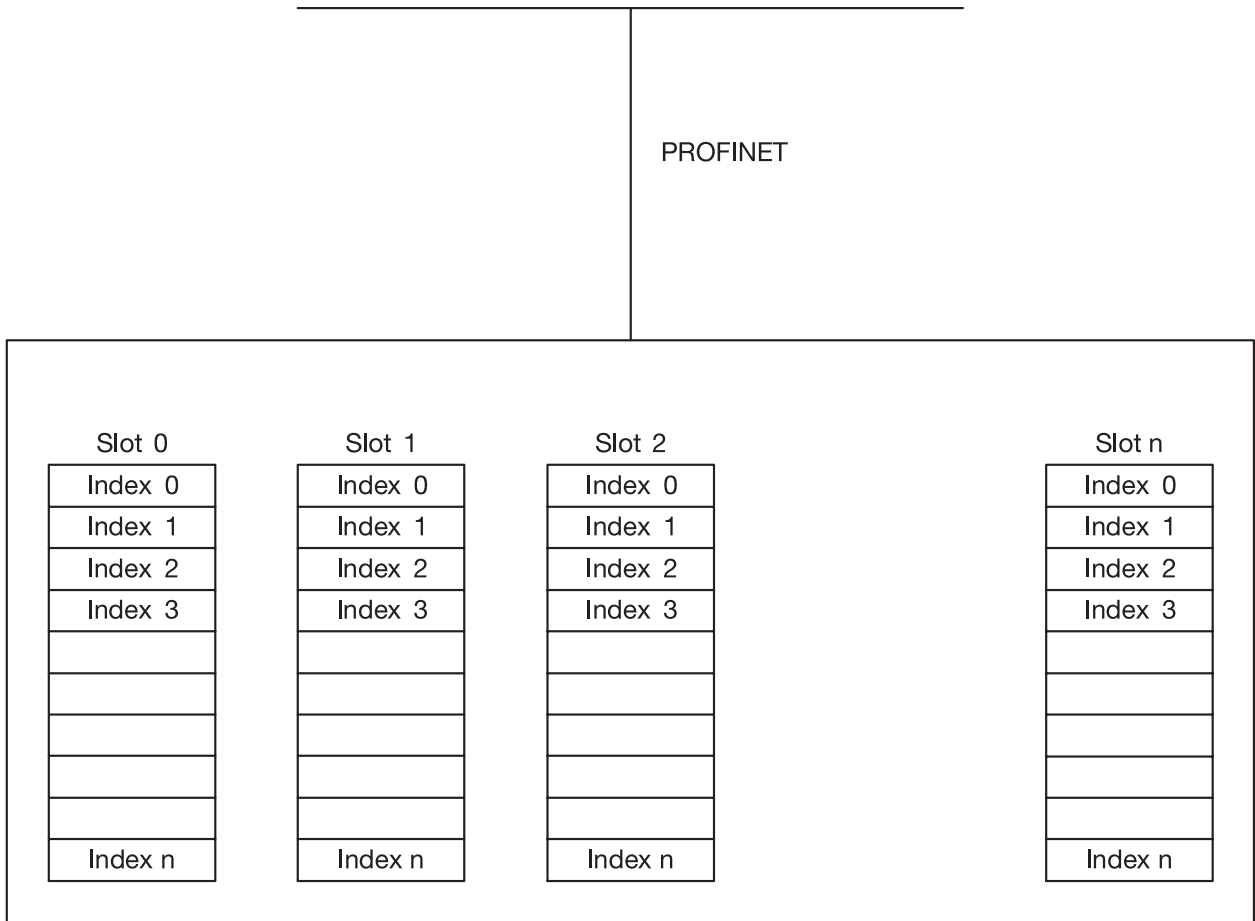

130BX339.10

Illustration 5.1 PROFINET IO Device Structure

5.4 Acyclic Read/Write Request Sequence

A read or write service on a frequency converter parameter takes place as illustrated in *Illustration 5.2*.

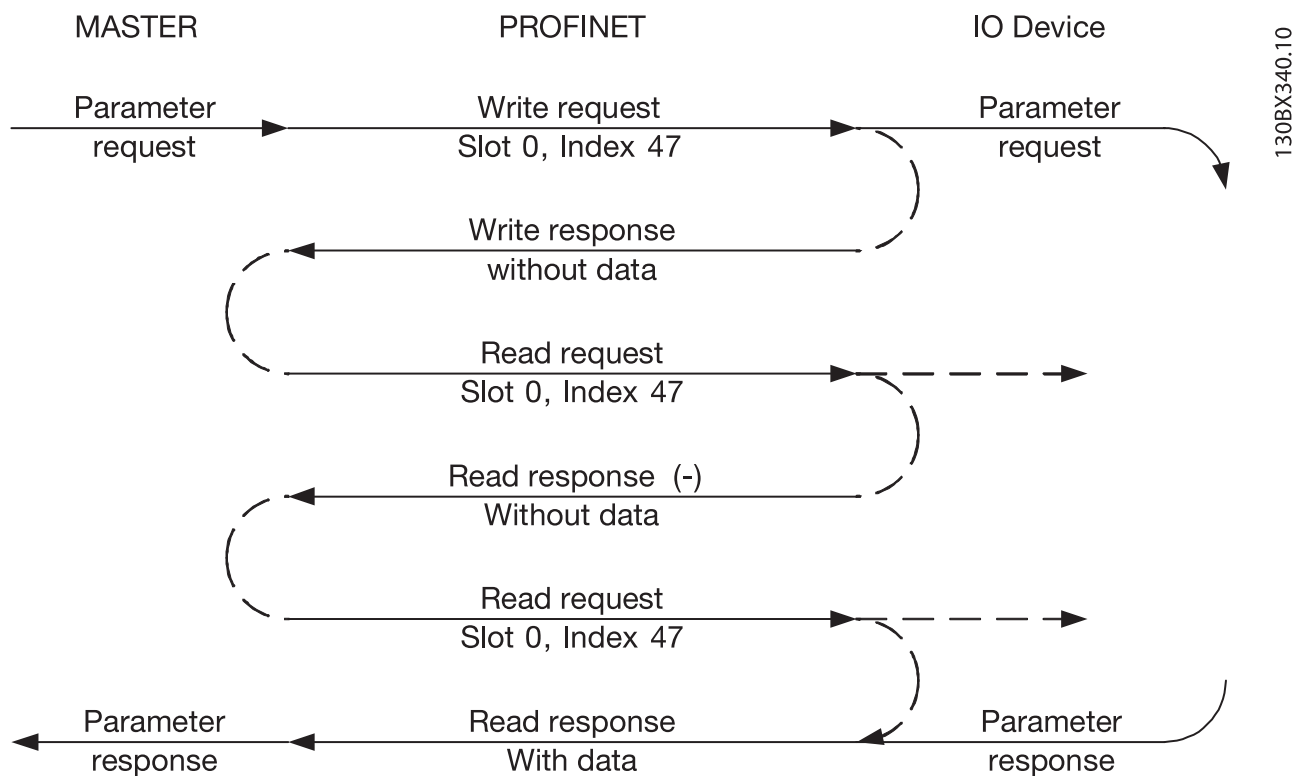

Illustration 5.2 Acyclic Read/Write Request Sequence

Initiate a read or write on a frequency converter parameter by an acyclic write service on slot 0, index 47. If this write request is valid, a positive write response without data is returned from the frequency converter immediately. If not, a negative write response is returned from the frequency converter.

The frequency converter now interprets the PROFdrive parameter channel part of the data unit, and start to perform this command internally in the frequency converter.

As the next step, the master sends a read request. If the frequency converter is still busy performing the internal parameter request, a negative response without data is returned from the frequency converter. This request is repeated by the master, until the frequency converter has the response data ready for the frequency converter parameter request.

The following example shows the details of the telegrams needed for the read/write service.

5.5 Data Structure in the Acyclic Telegrams

The data structure for a write/read parameter request, consists of 3 main blocks:

- Header block
- Parameter block
- Data block

Arrange according to *Table 5.1:*

Word number		
1 Header	Request #	Request ID
2 Header	Axis	# Param.
3 (Param. 1)	Attribute	# Elements
4 (Param. 1)	Parameter number	
5 (Param. 1)	Subindex number	
6 (Param. 2)	Attribute	# Elements
7 (Param. 2)	Parameter number	
8 (Param. 2)	Subindex number	
9 (Param. 3)	Attribute	# Elements
10 (Param. 3)	Parameter number	
11 (Param. 3)	Subindex number	
...		
N (Data Param. 1)	Format	# Elements
N+1 (Data Param. 1)	Data	Data
N (Data Param. 2)	Format	# Elements
N+1 (Data Param. 2)	Data	Data
N (Data Param. 3)	Format	# Elements
N+1 (Data Param. 3)	Data	Data
N+1 (Data Param. 3)	Data	Data
N+1 (Data Param. 3)	Data	Data

Table 5.1 Request Telegram

5.6 Header

Request number

The master uses request # to handle the response from the IO device. The IO device mirrors this number in its response.

Request ID

- 1=request parameter
- 2=change parameter

Axis

Always leave this to 0 (zero).
Only used in multi-axis system.

Number of parameters

Number of parameters to read or write.

5.7 Parameter Block

Provide the following 5 values for each parameter to read.

Attribute

Attribute to be read

10=Value

20=Description

30=Text

Number of elements

The number of elements to read, when parameter is indexed.

Attribute

Read attribute.

Parameter number

The number of the parameter to read.

Subindex

Pointer to the index.

5.8 Data Block

The data block is only needed for write commands. Set up the data block information for each parameter to write.

Format

The format of the information to write:

- 2: Integer 8
- 3: Integer 16
- 4: Integer 32
- 5: Unsigned 8
- 6: Unsigned 16
- 7: Unsigned 32
- 9: Visible string
- 33: Normalised value 2 bytes
- 35: Bit sequence of 16 boolean variables
- 54: Time difference without date

For the individual frequency converter series, the Programming Guide of the frequency converter contains a table with parameter number, format, and other relevant information.

Data

The actual value to transfer. The amount of data has to be exactly the size requested in the parameter block. If the size differs, the request generates an error.

On a successful transmission of a request command, the master can read the response from the frequency converter. The response does look very much like the request command. The response only consists of 2 blocks, the header and the data block.

1 Header	Request #	Request ID
2 Header	Axis	# Param.
3 (Data Param. 1)	Format	Error code
4 (Data Param. 1)	Data	Data
5 (Data Param. 2)	Format	Error code
6 (Data Param. 2)	Data	Data
7 (Data Param. 3)	Format	Error code
8 (Data Param. 3)	Data	Data
9 (Data Param. 3)	Data	Data
10 (Data Param. 3)	Data	Data

Table 5.2 Response Telegram
Error code

If the IO device discovers an error during the execution of the command, it sets the error code to the following values:

0x00	Unknown parameter
0x01	Parameter is read-only
0x02	Value out of range due to max/min value
0x03	Wrong subindex
0x04	Parameter is no array
0x05	Wrong datatype (wrong data length)
0x06	It is not allowed to set this parameter (only reset)
0x07	Descriptive element is read-only
0x09	No description available (only value)
0x0b	Process control not possible
0x0f	No text array available (only value)
0x11	Not possible in current state
0x14	Value out of range due to drive state/configuration
0x15	Reply too long (more than 240 bytes)
0x16	Wrong parameter address (unknown or unsupported value for attribute, element, parameter number, or subindex or illegal combination)
0x17	Illegal format (for writing)
0x18	Value amount not consistent
0x65	Wrong axis: action not possible with this axis
0x66	Unknown service request
0x67	This service is not possible with multi-parameter access
0x68	Parameter value cannot be read from bus

Table 5.3 Error Code

6 Parameters

6.1 Parameter Group 0-** Operation/Display

0-37 Display Text 1		
Range:	Function:	
0* [0 - 25]	In this parameter, it is possible to write an individual text string for display in the LCP or to be read via serial communication. If to be displayed permanently, select [37] <i>Display Text 1 in 0-20 Display Line 1.1 Small, 0-21 Display Line 1.2 Small, 0-22 Display Line 1.3 Small, 0-23 Display Line 2 Large or 0-24 Display Line 3 Large. Parameter 0-37 Display Text 1 is linked to parameter 12-08 Host Name. Changing parameter 12-08 Host Name changes Parameter 0-37 Display Text 1 - but not in the other direction.</i>	

6.2 Parameter Group 8-** Communication and Option

8-01 Control Site		
Option:	Function:	
	The setting in this parameter overrides the settings in <i>parameter 8-50 Coasting Select to parameter 8-56 Preset Reference Select.</i>	
[0] Digital and ctrl.word	Control by using both digital input and control word.	
[1] Digital only	Control by using digital inputs only.	
[2] Controlword only	Control by using control word only.	

8-02 Control Word Source		
Option:	Function:	
	<p>NOTICE</p> <p>This parameter cannot be adjusted while the motor is running.</p> <p>Select the source of the control word: 1 of 2 serial interfaces or 4 installed options. During initial power-up, the frequency converter automatically sets this parameter to [3] <i>Option A</i>, if it detects a valid fieldbus option installed in slot A. When the option is removed, the frequency converter detects a configuration change, sets <i>parameter 8-02 Control Word Source</i> to default setting RS485, and trips. If an option is installed after initial power-up, the setting of <i>parameter 8-02 Control Word Source</i> does not change, but the frequency converter trips and displays: <i>Alarm 67, Option Changed.</i></p>	

8-02 Control Word Source		
Option:	Function:	
	When retrofitting a bus option into a frequency converter that did not have a bus option installed earlier, change the control to bus-based. This is required for safety reasons to avoid an accidental change.	
[0]	None	
[1]	FC RS485	
[2]	FC USB	
[3]	Option A	
[4]	Option B	
[5]	Option C0	
[6]	Option C1	
[30]	External Can	

8-03 Control Word Timeout Time		
Range:	Function:	
1 s* [0.1 - 18000 s]	Enter the maximum time expected to pass between the reception of 2 consecutive telegrams. If this time is exceeded, it indicates that the telegram communication has stopped. The function selected in <i>parameter 8-04 Control Word Timeout Function</i> is then carried out. A valid control word triggers the time-out counter.	

8-04 Control Word Timeout Function		
Select the time-out function. The time-out function activates when the control word fails to be updated within the time period specified in <i>parameter 8-03 Control Word Timeout Time.</i>		
Option:	Function:	
[0]	Off	Resumes control via serial bus (fieldbus or standard) using the most recent control word.
[1]	Freeze output	Freezes output frequency until communication resumes.
[2]	Stop	Stops with auto restart when communication resumes.
[3]	Jogging	Runs the motor at jog frequency until communication resumes.
[4]	Max. speed	Runs the motor at maximum frequency until communication resumes.
[5]	Stop and trip	Stops the motor, then resets the frequency converter to restart: Via the fieldbus, via [Reset], or via a digital input.
[7]	Select setup 1	Changes the set-up upon reestablishment of communication following a control word

8-04 Control Word Timeout Function		
Select the time-out function. The time-out function activates when the control word fails to be updated within the time period specified in <i>parameter 8-03 Control Word Timeout Time</i> .		
Option:	Function:	
	timeout. If communication resumes after a timeout, <i>parameter 8-05 End-of-Timeout Function</i> defines whether to resume the set-up used before the timeout, or to retain the set-up endorsed by the timeout function.	
[8]	Select setup 2	See [7] <i>Select set-up 1</i>
[9]	Select setup 3	See [7] <i>Select set-up 1</i>
[10]	Select setup 4	See [7] <i>Select set-up 1</i>
[26]	Trip	

NOTICE

To change the set-up after a timeout, configure as follows:
 Set 0-10 *Active Set-up* to [9] *Multi set-up* and select the relevant link in 0-12 *This Set-up Linked to*.

8-05 End-of-Timeout Function		
Option:	Function:	
	Select the action after receiving a valid control word following a timeout. This parameter is active only when 8-04 <i>Control Timeout Function</i> is set to [7] <i>Set-up 1</i> , [8] <i>Set-up 2</i> , [9] <i>Set-up 3</i> or [10] <i>Set-up 4</i> .	
[0]	Hold set-up	Retains the set-up selected in 8-04 <i>Control Timeout Function</i> and displays a warning, until 8-06 <i>Reset Control Timeout</i> toggles. Then the frequency converter resumes its original set-up.
[1] *	Resume set-up	Resumes the set-up active before the timeout.

8-06 Reset Control Word Timeout		
This parameter is active only when [0] <i>Hold set-up</i> has been selected in <i>parameter 8-05 End-of-Timeout Function</i> .		
Option:	Function:	
[0] *	Do not reset	Retains the set-up specified in <i>parameter 8-04 Control Word Timeout Function</i> , following a control word timeout.
[1]	Do reset	Returns the frequency converter to the original set-up following a control word timeout. The frequency converter performs the reset and then immediately reverts to the [0] <i>Do not reset</i> setting.

8-07 Diagnosis Trigger		
Option:	Function:	
	Enables and controls the frequency converter diagnosis function.	

8-07 Diagnosis Trigger		
Option:	Function:	
[0] *	Disable	Extended diagnosis data are not sent even if they appear in the frequency converter.
[1]	Trigger on alarms	Extended diagnosis data are sent when 1 or more alarms appear.
[2]	Trigger alarm/warn.	Extended diagnosis data are sent if one or more alarms/warnings appear.

8-08 Readout Filtering		
If the speed feedback value readouts on fieldbus are fluctuating, this function is used. Select filtered, if the function is required. A power-cycle is required for changes to take effect.		
Option:	Function:	
[0]	Motor Data Std-Filt.	Normal bus readouts.
[1]	Motor Data LP-Filter	Filtered bus readouts of the following parameters: 16-10 Power [kW] 16-11 Power [hp] 16-12 Motor Voltage 16-14 Motor current 16-16 Torque [Nm] 16-17 Speed [RPM] 16-22 Torque [%] 16-25 Torque [Nm] High

8-10 Control Word Profile		
Select the interpretation of the control and status words corresponding to the installed fieldbus. Only the selections valid for the fieldbus installed in slot A are visible in the LCP display. For guidelines in selection of [0] <i>Frequency converter profile</i> and [1] <i>PROFdrive profile</i> , refer to the design guide of the related product. For additional guidelines in the selection of [1] <i>PROFdrive profile</i> , [5] <i>ODVA</i> and [7] <i>CANopen DSP 402</i> , see the installation guide for the installed fieldbus.		
Option:	Function:	
[0] *	FC profile	
[1]	PROFdrive profile	
[5]	ODVA	
[7]	CANopen DSP 402	
[8]	MCO	

8-13 Configurable Status Word STW		
The status word has 16 bits (0-15). Bits 5 and 12-15 are configurable. Each of these bits can be configured to any of the following options.		
Option:	Function:	
[0]	No function	The input is always low.
[1]	Profile Default	Depending on the profile set in 8-10 <i>Control Profile</i> .

8-13 Configurable Status Word STW		
The status word has 16 bits (0-15). Bits 5 and 12-15 are configurable. Each of these bits can be configured to any of the following options.		
Option:	Function:	
[2]	Alarm 68 Only	The input goes high whenever Alarm 68 is active, and goes low whenever alarm 68 is not activated.
[3]	Trip excl Alarm 68	
[10]	T18 DI status	
[11]	T19 DI status	
[12]	T27 DI status	
[13]	T29 DI status	
[14]	T32 DI status	
[15]	T33 DI status	
[16]	T37 DI status	The input goes high whenever terminal 37 has 0 V and goes low whenever terminal 37 has 24 V.
[21]	Thermal warning	
[30]	Brake fault (IGBT)	
[40]	Out of ref range	
[41]	Load throttle active	
[60]	Comparator 0	
[61]	Comparator 1	
[62]	Comparator 2	
[63]	Comparator 3	
[64]	Comparator 4	
[65]	Comparator 5	
[70]	Logic Rule 0	
[71]	Logic Rule 1	
[72]	Logic Rule 2	
[73]	Logic Rule 3	
[74]	Logic Rule 4	
[75]	Logic Rule 5	
[80]	SL digital out A	
[81]	SL digital out B	
[82]	SL digital out C	
[83]	SL digital out D	
[84]	SL digital out E	
[85]	SL digital out F	
[86]	ATEX ETR cur. alarm	
[87]	ATEX ETR freq. alarm	
[88]	ATEX ETR cur. warning	
[89]	ATEX ETR freq. warning	
[90]	Safe Function active	
[91]	Safe Opt. Reset req.	

8-14 Configurable Control Word CTW		
Option:	Function:	
[0]	None	Selection of control word bit 10 if it is active low or active high.

8-14 Configurable Control Word CTW		
Option:	Function:	
[1] *	Profile default	
[2]	CTW Valid, active low	
[3]	Safe Option Reset	
[4]	PID error inverse	
[5]	PID reset I part	
[6]	PID enable	

8-19 Product Code		
Range:	Function:	
Size related*	[0 - 2147483647]	Select [0] to readout the actual fieldbus product code according to the mounted fieldbus option. Select [1] to read out the actual Vendor ID.

8-46 BTM Transaction Status		
Option:	Function:	
[0] *	Off	
[1]	Transaction Started	
[2]	Transaction Comitting	
[3]	Transaction Timeout	
[4]	Err. Non-existing Par.	
[5]	Err. Par. Out of Range	
[6]	Transaction Failed	

8-47 BTM Timeout		
Range:	Function:	
60 s*	[1 - 360 s]	Select the BTM Timeout after a BTM transaction has been started.

8-48 BTM Maximum Errors		
Range:	Function:	
21*	[0 - 21]	Selects the maximum allowed number of bulk transfer mode errors before aborting. If it is set to maximum, there is no abort.

8-49 BTM Error Log		
Range:	Function:	
0.255*	[0.000 - 9999.255]	List of parameters that failed during bulk transfer mode. The value after the decimal break is the error code (255 means no error).

8-50 Coasting Select		
Option:	Function:	
[0]	Digital input	Select control of the coasting function via the terminals (digital input) and/or via the bus. Activates start command via a digital input.
[1]	Bus	Activates start command via the serial communication port or fieldbus option.

8-50 Coasting Select		
Option:	Function:	
[2]	Logic AND	Activates start command via the fieldbus/serial communication port, AND additionally via one of the digital inputs.
[3] *	Logic OR	Activates start command via the fieldbus/serial communication port OR via one of the digital inputs.

8-51 Quick Stop Select		
Select control of the Quick Stop function via the terminals (digital input) and/or via the bus.		
Option:	Function:	
[0]	Digital input	
[1]	Bus	
[2]	Logic AND	
[3] *	Logic OR	

8-52 DC Brake Select		
Option:	Function:	
		Select control of the DC brake via the terminals (digital input) and/or via the fieldbus. NOTICE when 1-10 Motor Construction is set to [1] PM non-salient SPM, only selection [0] Digital input is available.
[0]	Digital input	Activates start command via a digital input.
[1]	Bus	Activates start command via the serial communication port or fieldbus option.
[2]	Logic AND	Activates start command via the fieldbus/serial communication port, AND additionally via one of the digital inputs.
[3]	Logic OR	Activates start command via the fieldbus/serial communication port OR via one of the digital inputs.

8-53 Start Select		
Option:	Function:	
		Select control of the frequency converter start function via the terminals (digital input) and/or via the fieldbus.
[0]	Digital input	Activates a start command via a digital input.
[1]	Bus	Activates a start command via the serial communication port or fieldbus option.
[2]	Logic AND	Activates a start command via the fieldbus/serial communication port, AND additionally via one of the digital inputs.

8-53 Start Select		
Option:	Function:	
[3] *	Logic OR	Activates a start command via the fieldbus/serial communication port, OR via 1 of the digital inputs.

8-54 Reversing Select		
Option:	Function:	
[0]	Digital input	Select control of the frequency converter reverse function via the terminals (digital input) and/or via the fieldbus.
[1]	Bus	Activates the reverse command via the serial communication port, or fieldbus option.
[2]	Logic AND	Activates the reverse command via the fieldbus/serial communication port, AND additionally via 1 of the digital inputs.
[3] *	Logic OR	Activates the reverse command via the fieldbus/serial communication port, OR via 1 of the digital inputs.

8-55 Set-up Select		
Option:	Function:	
		Select control of the frequency converter set-up selection via the terminals (digital input) and/or via the fieldbus.
[0]	Digital input	Activates the set-up selection via a digital input.
[1]	Bus	Activates the set-up selection via the serial communication port or fieldbus option.
[2]	Logic AND	Activates the set-up selection via the fieldbus/serial communication port, AND additionally via one of the digital inputs.
[3] *	Logic OR	Activate the set-up selection via the fieldbus/serial communication port OR via one of the digital inputs.

8-56 Preset Reference Select		
Option:	Function:	
		Select control of the preset reference selection via the terminals (digital input) and/or via the fieldbus.
[0]	Digital input	Activates preset reference selection via a digital input.
[1]	Bus	Activates preset reference selection via the serial communication port or fieldbus option.
[2]	Logic AND	Activates preset reference selection via the fieldbus/serial communication port, AND additionally via one of the digital inputs.
[3] *	Logic OR	Activates the preset reference selection via the fieldbus/serial communication port OR via one of the digital inputs.

8-90 Bus Jog 1 Speed		
Range:	Function:	
100 RPM* [0 - par. 4-13 RPM]	Enter the jog speed. Activate this fixed jog speed via the serial port or fieldbus option.	

8-91 Bus Jog 2 Speed		
Range:	Function:	
200 RPM* [0 - par. 4-13 RPM]	Enter the jog speed. Activate this fixed jog speed via the serial port or fieldbus option.	

6.3 Parameter Group 9-** PROFIdrive

9-15 PCD Write Configuration

Array [10]

Option: Function:

	Select the parameters to be assigned to PCD 3-10 of the telegrams. The number of available PCDs depends on the telegram type. The values in PCD 3-10 are then written to the selected parameters as data values. Alternatively, specify a standard PROFIBUS telegram in <i>9-22 Telegram Selection</i> .
--	--

9-16 PCD Read Configuration

Array [10]

Option: Function:

	Select the parameters to be assigned to PCD 3-10 of the telegrams. The number of available PCDs depends on the telegram type. PCDs 3-10 contain the actual data values of the selected parameters. For standard PROFIBUS telegram, see <i>9-22 Telegram Selection</i> .
--	---

9-22 Telegram Selection

Option:	Function:	
	This parameter shows the selected standard PROFIBUS telegram that the PROFINET IO controller has sent to the frequency converter. At power-up or if a non-supported telegram is sent from the IO controller this parameter shows None in the display.	
[1]	Standard telegram 1	
[100] *	None	
[101]	PPO 1	
[102]	PPO 2	
[103]	PPO 3	
[104]	PPO 4	
[105]	PPO 5	
[106]	PPO 6	
[107]	PPO 7	
[108]	PPO 8	

9-23 Parameters for Signals

Array [1000]

Read only

Option:	Function:	
	This parameter contains a list of signals available for selection in <i>9-15 PCD Write Configuration</i> and <i>9-16 PCD Read Configuration</i> .	
[0] *	None	
[15]	Readout: actual setup	
[302]	Minimum Reference	
[303]	Maximum Reference	
[312]	Catch up/slow Down Value	
[341]	Ramp 1 Ramp Up Time	
[342]	Ramp 1 Ramp Down Time	
[351]	Ramp 2 Ramp Up Time	
[352]	Ramp 2 Ramp Down Time	
[380]	Jog Ramp Time	
[381]	Quick Stop Ramp Time	
[411]	Motor Speed Low Limit [RPM]	
[412]	Motor Speed Low Limit [Hz]	
[413]	Motor Speed High Limit [RPM]	
[414]	Motor Speed High Limit [Hz]	
[416]	Torque Limit Motor Mode	
[417]	Torque Limit Generator Mode	
[553]	Term. 29 High Ref./Feedb. Value	
[558]	Term. 33 High Ref./Feedb. Value	
[590]	Digital & Relay Bus Control	
[593]	Pulse Out #27 Bus Control	
[595]	Pulse Out #29 Bus Control	
[597]	Pulse Out #X30/6 Bus Control	
[615]	Terminal 53 High Ref./Feedb. Value	
[625]	Terminal 54 High Ref./Feedb. Value	
[653]	Term 42 Output Bus Ctrl	
[663]	Terminal X30/8 Bus Control	
[673]	Terminal X45/1 Bus Control	
[683]	Terminal X45/3 Bus Control	
[748]	PCD Feed Forward	
[890]	Bus Jog 1 Speed	
[891]	Bus Jog 2 Speed	
[1472]	Legacy Alarm Word	
[1473]	Legacy Warning Word	
[1474]	Leg. Ext. Status Word	
[1500]	Operating hours	
[1501]	Running Hours	
[1502]	kWh Counter	
[1600]	Control Word	
[1601]	Reference [Unit]	
[1602]	Reference %	
[1603]	Status Word	
[1605]	Main Actual Value [%]	

9-23 Parameters for Signals		
Array [1000]		
Read only		
Option:	Function:	
[1606]	Absolute Position	
[1609]	Custom Readout	
[1610]	Power [kW]	
[1611]	Power [hp]	
[1612]	Motor Voltage	
[1613]	Frequency	
[1614]	Motor current	
[1615]	Frequency [%]	
[1616]	Torque [Nm]	
[1617]	Speed [RPM]	
[1618]	Motor Thermal	
[1619]	KTY sensor temperature	
[1620]	Motor Angle	
[1621]	Torque [%] High Res.	
[1622]	Torque [%]	
[1623]	Motor Shaft Power [kW]	
[1624]	Calibrated Stator Resistance	
[1625]	Torque [Nm] High	
[1630]	DC Link Voltage	
[1632]	Brake Energy /s	
[1633]	Brake Energy Average	
[1634]	Heatsink Temp.	
[1635]	Inverter Thermal	
[1638]	SL Controller State	
[1639]	Control Card Temp.	
[1645]	Motor Phase U Current	
[1646]	Motor Phase V Current	
[1647]	Motor Phase W Current	
[1648]	Speed Ref. After Ramp [RPM]	
[1650]	External Reference	
[1651]	Pulse Reference	
[1652]	Feedback[Unit]	
[1653]	Digi Pot Reference	
[1657]	Feedback [RPM]	
[1660]	Digital Input	
[1661]	Terminal 53 Switch Setting	
[1662]	Analog Input 53	
[1663]	Terminal 54 Switch Setting	
[1664]	Analog Input 54	
[1665]	Analog Output 42 [mA]	
[1666]	Digital Output [bin]	
[1667]	Freq. Input #29 [Hz]	
[1668]	Freq. Input #33 [Hz]	
[1669]	Pulse Output #27 [Hz]	
[1670]	Pulse Output #29 [Hz]	
[1671]	Relay Output [bin]	
[1672]	Counter A	
[1673]	Counter B	
[1674]	Prec. Stop Counter	
[1675]	Analog In X30/11	

9-23 Parameters for Signals		
Array [1000]		
Read only		
Option:	Function:	
[1676]	Analog In X30/12	
[1677]	Analog Out X30/8 [mA]	
[1678]	Analog Out X45/1 [mA]	
[1679]	Analog Out X45/3 [mA]	
[1680]	Fieldbus CTW 1	
[1682]	Fieldbus REF 1	
[1684]	Comm. Option STW	
[1685]	FC Port CTW 1	
[1686]	FC Port REF 1	
[1687]	Bus Readout Alarm/Warning	
[1689]	Configurable Alarm/Warning Word	
[1690]	Alarm Word	
[1691]	Alarm Word 2	
[1692]	Warning Word	
[1693]	Warning Word 2	
[1694]	Ext. Status Word	
[1836]	Analog Input X48/2 [mA]	
[1837]	Temp. Input X48/4	
[1838]	Temp. Input X48/7	
[1839]	Temp. Input X48/10	
[1860]	Digital Input 2	
[3310]	Sync Factor Master	
[3311]	Sync Factor Slave	
[3401]	PCD 1 Write to MCO	
[3402]	PCD 2 Write to MCO	
[3403]	PCD 3 Write to MCO	
[3404]	PCD 4 Write to MCO	
[3405]	PCD 5 Write to MCO	
[3406]	PCD 6 Write to MCO	
[3407]	PCD 7 Write to MCO	
[3408]	PCD 8 Write to MCO	
[3409]	PCD 9 Write to MCO	
[3410]	PCD 10 Write to MCO	
[3421]	PCD 1 Read from MCO	
[3422]	PCD 2 Read from MCO	
[3423]	PCD 3 Read from MCO	
[3424]	PCD 4 Read from MCO	
[3425]	PCD 5 Read from MCO	
[3426]	PCD 6 Read from MCO	
[3427]	PCD 7 Read from MCO	
[3428]	PCD 8 Read from MCO	
[3429]	PCD 9 Read from MCO	
[3430]	PCD 10 Read from MCO	
[3440]	Digital Inputs	
[3441]	Digital Outputs	
[3450]	Actual Position	
[3451]	Commanded Position	
[3452]	Actual Master Position	
[3453]	Slave Index Position	
[3454]	Master Index Position	

9-23 Parameters for Signals		
Array [1000]		
Read only		
Option:	Function:	
[3455]	Curve Position	
[3456]	Track Error	
[3457]	Synchronizing Error	
[3458]	Actual Velocity	
[3459]	Actual Master Velocity	
[3460]	Synchronizing Status	
[3461]	Axis Status	
[3462]	Program Status	
[3464]	MCO 302 Status	
[3465]	MCO 302 Control	
[3470]	MCO Alarm Word 1	
[3471]	MCO Alarm Word 2	
[4280]	Safe Option Status	
[4282]	Safe Control Word	
[4283]	Safe Status Word	
[4285]	Active Safe Func.	

9-27 Parameter Edit		
Option:	Function:	
		Parameters can be edited via Profibus, the standard RS-485 interface, or the LCP.
[0]	Disabled	Disables editing via Profibus.
[1] *	Enabled	Enables editing via Profibus.

9-28 Process Control		
Option:	Function:	
		Process control (setting of control word, speed reference, and process data) is possible via either PROFINET or standard fieldbus, but not both simultaneously. Local control is always possible via the LCP. Control via process control is possible via either terminals or fieldbus depending on the settings in <i>parameter 8-50 Coasting Select</i> to <i>parameter 8-56 Preset Reference Select</i> .
[0]	Disable	Disables process control via PROFINET, and enables process control via standard fieldbus or PROFINET IO supervisor.
[1] *	Enable cyclic master	Enables process control via IO controller, and disables process control via standard fieldbus or PROFINET IO supervisor.

9-53 Profibus Warning Word		
Range:	Function:	
0*	[0 - 65535]	This parameter displays PROFINET communication warnings.

Read only

Bit	Condition when bit is active
0	Connection with IO controller is not ok
1	Reserved for status of connection with second IO controller
2	Not used
3	Clear data command received
4	Actual value is not updated
5	No link on both port
6	Not used
7	Initialising of PROFINET is not ok
8	Drive is tripped
9	Internal CAN error
10	Wrong configuration data from IO controller
11	Not used
12	Internal error occurred
13	Not configured
14	Timeout active
15	Warning 34 active

Table 6.1 PROFINET Communication Warnings

9-65 Profile Number		
Range:	Function:	
0*	[0 - 0]	This parameter contains the profile identification. Byte 1 contains the profile number and byte 2 the version number of the profile.

NOTICE

This parameter is not visible via LCP.

9-70 Programming Set-up		
Option:	Function:	
		Select the set-up to be edited.
[0]	Factory setup	Uses default data. This option can be used as a data source to return the other set-ups to a known state.
[1]	Set-up 1	Edits Set-up 1.
[2]	Set-up 2	Edits Set-up 2.
[3]	Set-up 3	Edits Set-up 3.
[4]	Set-up 4	Edits Set-up 4.
[9] *	Active Set-up	Follows the active set-up selected in <i>0-10 Active Set-up</i> .

This parameter is unique for LCP and fieldbus. See *0-11 Programming Set-up*.

9-71 Profibus Save Data Values		
Option:	Function:	
		Parameter values changed via PROFINET are not automatically stored in non-volatile memory. Use this parameter to activate a function that stores parameter values in the EEPROM non-

9-71 Profibus Save Data Values		
Option:	Function:	
		volatile memory, so changed parameter values are retained at power-down.
[0] *	Off	Deactivates the non-volatile storage function.
[1]	Store all setups	Stores all parameter values for all set-ups in the non-volatile memory. When all parameter values have been stored, the selection returns to [0] Off.
[2]	Store all setups	Stores all parameter values for all set-ups in the non-volatile memory. When all parameter values have been stored, the selection returns to [0] Off.

9-72 ProfibusDriveReset		
Option:	Function:	
[0] *	No action	
[1]	Power-on reset	Resets frequency converter upon power-up, as for power-cycle.
[3]	Comm option reset	Resets the PROFINET option only, the PROFINET option goes through a power-up sequence. When reset, the frequency converter disappears from the fieldbus, which may cause a communication error from the master.

9-80 Defined Parameters (1)		
Array [116] No LCP access Read only		
Range:	Function:	
0* [0 - 9999]	This parameter displays a list of all the defined frequency converter parameters available for PROFINET.	

9-81 Defined Parameters (2)		
Array [116] No LCP access Read only		
Range:	Function:	
0* [0 - 9999]	This parameter displays a list of all the defined frequency converter parameters available for PROFINET.	

9-82 Defined Parameters (3)		
Array [116] No LCP access Read only		
Range:	Function:	
0* [0 - 9999]	This parameter displays a list of all the defined frequency converter parameters available for PROFINET.	

9-83 Defined Parameters (4)		
Array [116] No LCP access Read only		
Range:	Function:	
0* [0 - 9999]	This parameter displays a list of all the defined frequency converter parameters available for PROFINET.	

9-84 Defined Parameters (5)		
Array [115] No LCP access Read only		
Range:	Function:	
0* [0 - 9999]	This parameter displays a list of all the defined frequency converter parameters available for PROFINET.	

9-90 Changed Parameters (1)		
Array [116] No LCP access Read only		
Range:	Function:	
0* [0 - 9999]	This parameter displays a list of all the frequency converter parameters deviating from default setting.	

9-91 Changed Parameters (2)		
Array [116] No LCP access Read only		
Range:	Function:	
0* [0 - 9999]	This parameter displays a list of all the frequency converter parameters deviating from default setting.	

9-92 Changed Parameters (3)		
Array [116] No LCP access Read only		
Range:	Function:	
0* [0 - 9999]	This parameter displays a list of all the frequency converter parameters deviating from default setting.	

9-94 Changed Parameters (5)		
Array [116] No LCP Address Read only		
Range:	Function:	
0* [0 - 9999]	This parameter displays a list of all the frequency converter parameters deviating from default setting.	

6.4 Parameter Group 12-** Ethernet

6.4.1 12-0* IP Settings

12-00 IP Address Assignment		
Option:	Function:	
		Selects the IP address assignment method.
[0]	MANUAL	IP-address can be set in <i>parameter 12-01 IP Address</i> IP Address.
[1]	DHCP	IP-address is assigned via DHCP server.
[2]	BOOTP	IP-address is assigned via BOOTP server.
[10]	DCP	
[20]	From node ID	

12-01 IP Address		
Range:	Function:	
0*	[0 - 2147483647]	Configure the IP address of the option. Read-only if <i>parameter 12-00 IP Address Assignment</i> set to DHCP or BOOTP. In POWERLINK, the IP address follows the <i>12-60 Node ID</i> last byte and the first part is fixed to 192.168.100 (node ID).

12-02 Subnet Mask		
Range:	Function:	
0*	[0 - 4244635647]	Configure the IP subnet mask of the option. Read-only if <i>parameter 12-00 IP Address Assignment</i> set to DHCP or BOOTP. In POWERLINK it is fixed to 255.255.255.0.

12-03 Default Gateway		
Range:	Function:	
0*	[0 - 2147483647]	Configure the IP default gateway of the option. Read-only if <i>parameter 12-00 IP Address Assignment</i> set to DHCP or BOOTP. In a non-routed network this address is set to the IP address of the IO Device

12-04 DHCP Server		
Range:	Function:	
0*	[0 - 2147483647]	Read only. Displays the IP address of the found DHCP or BOOTP server.

12-05 Lease Expires		
Range:	Function:	
Size related*	[0 - 0]	

12-06 Name Servers		
Range:	Function:	
0*	[0 - 2147483647]	IP addresses of Domain Name Servers. Can be automatically assigned when using DHCP.

12-07 Domain Name		
Range:	Function:	
0	[0 - 48]	Domain name of the attached network. Can be automatically assigned when using DHCP network.

12-08 Host Name		
Range:	Function:	
0*	[0 - 48]	Logical (given) name of option.

NOTICE

The display of the frequency converter only shows the first 19 characters, but the remaining characters are stored in the frequency converter. If hardware switches are different from all ON or all OFF, the switches have priority.

12-09 Physical Address		
Range:	Function:	
0*	[0 - 17]	Read-only. Displays the physical (MAC) address of the option.

6.4.2 12-1* Ethernet Link Parameters

Applies for the whole parameter group.

Index [0] is used for port 1, and Index [1] is used for port 2. For EtherCAT, index [0] is for the in-port and index [1] is for the out-port.

12-10 Link Status		
Option:	Function:	
		Read-only. Displays the link status of the Ethernet ports.
[0] *	No Link	
[1]	Link	

12-11 Link Duration		
Range:	Function:	
Size related*	[0 - 0]	Read-only. Displays the duration of the present link on each port in dd:hh:mm:ss.

12-12 Auto Negotiation		
Option:	Function:	
		Configures auto negotiation of Ethernet link parameters, for each port: ON or OFF.
[0]	Off	<i>Link Speed</i> and <i>Link Duplex</i> can be configured in <i>parameter 12-13 Link Speed</i> and <i>12-14 Link Duplex</i> .
[1] *	On	

NOTICE

In POWERLINK, this parameter is fixed to OFF setting.

12-13 Link Speed		
Option:	Function:	
		Forces the link speed for each port in 10 Mbps or 100 Mbps. If <i>parameter 12-12 Auto Negotiation</i> is set to: ON, this parameter is read-only and displays the actual link speed. If no link is present, <i>None</i> is displayed.
[0] *	None	
[1]	10 Mbps	
[2]	100 Mbps	

NOTICE

In POWERLINK, this parameter is locked to 100 Mbs.

12-14 Link Duplex		
Option:	Function:	
		Forces the duplex for each port to full or half duplex. If <i>12-12 Auto Negotiation</i> is set to: [ON], this parameter is read-only.
[0]	Half Duplex	
[1]	Full Duplex	

NOTICE

In POWERLINK this parameter is locked to half duplex.

6.4.3 12-8* Other Ethernet Services

12-80 FTP Server		
Option:	Function:	
[0] *	Disabled	Disables the built-in FTP server.
[1]	Enabled	Enables the built-in FTP server.

12-81 HTTP Server		
Option:	Function:	
[0] *	Disabled	
[1]	Enabled	Enables the built-in HTTP (web) server.

12-82 SMTP Service		
Option:	Function:	
[0] *	Disabled	
[1]	Enabled	Enables the SMTP (e-mail) service on the option.

12-89 Transparent Socket Channel Port		
Range:	Function:	
Size related*	[0 - 65535]	Configures the TCP port number for the transparent socket channel. This configuration enables FC telegrams to be sent transparently on Ethernet via TCP. Default value is 4000, 0 means disabled. The MCT 10 Set-up Software uses this port.

6.4.4 12-9* Advanced Ethernet Settings

12-90 Cable Diagnostic		
Option:	Function:	
		Enables/disables advanced cable diagnosis function. If enabled, the distance to cable errors can be read out in <i>parameter 12-93 Cable Error Length</i> . The parameter resumes to the default setting of disable after the diagnostics have finished.
[0] *	Disabled	
[1]	Enabled	

NOTICE

The cable diagnostics function is only issued on ports where there is no link (see *12-10 Link Status, Link Status*)

12-91 Auto Cross Over		
Option:	Function:	
[0]	Disabled	Disables the auto cross-over function.
[1] *	Enabled	Enables the auto cross-over function.

12-92 IGMP Snooping		
Option:	Function:	
		This prevents flooding of the Ethernet protocol stack by only forwarding multicast packets to ports that are member of the multicast group. In PROFINET this function is disabled.
[0]	Disabled	Disables the IGMP snooping function.
[1] *	Enabled	Enables the IGMP snooping function.

12-93 Cable Error Length		
Range:	Function:	
0*	[0 - 65535]	If cable diagnostics is enabled in <i>12-90 Cable Diagnostic</i> , the built-in switch is possible via time domain reflectometry (TDR). This measurement technique detects common cabling problems such as open circuits, short circuits, and impedance mismatches or breaks in transmission cables. The distance from the option to the error is displayed in meters with an accuracy of ± 2 m. The value 0 means that no errors detected.

12-94 Broadcast Storm Protection		
Range:	Function:	
-1 %*	[-1 - 20 %]	The built-in switch is capable of protecting the switch system from receiving too many broadcast packages, which can use up network resources. The value indicates a percentage of the total bandwidth that is allowed for broadcast messages. Example:

12-94 Broadcast Storm Protection		
Range:		Function:
		OFF means that the filter is disabled - all broadcast messages passes through. The value 0% means that no broadcast messages passes through. A value of 10% means that 10% of the total bandwidth is allowed for broadcast messages. If the amount of broadcast messages increases above the 10% threshold, they are blocked.
-1 %*	[-1 - 20 %]	

12-95 Broadcast Storm Filter		
Option:		Function:
		Applies to <i>parameter 12-94 Broadcast Storm Protection</i> , if the broadcast storm protection should also include multicast telegrams.
[0] *	Broadcast only	
[1]	Broadcast & Multicast	

12-96 Port Config		
Enables/disables port-mirroring function. For troubleshooting with a network analyser tool.		
Option:		Function:
[0]	Normal	No port-mirroring
[1]	Mirror Port 1 to 2	All network traffic on port 1 is mirrored to port 2.
[2]	Mirror Port 2 to 1	All network traffic on port 2 is mirrored to port 1.
[10]	Port 1 disabled	
[11]	Port 2 disabled	
[254]	Mirror Int. Port to 1	
[255]	Mirror Int. Port to 2	

12-98 Interface Counters		
Range:		Function:
4000*	[0 - 4294967295]	Read-only. Advanced interface counters from built-in switch, can be used for low-level troubleshooting. The parameter shows a sum of port 1+port 2.

12-99 Media Counters		
Range:		Function:
0*	[0 - 4294967295]	Read-only. Advanced interface counters from built-in switch can be used for low-level troubleshooting. The parameter shows a sum of port 1+port 2.

6.5 PROFINET-specific Parameters

6.5.1 Setting Communication Parameters

All basic communication parameters are located in parameter group *12-0* IP Settings*. The parameters are all set to PROFINET standard values, so that only a minimum change is necessary.

- *12-00 IP Address Assignment*
- *12-01 IP Address*
- *Parameter 12-02 Subnet Mask*
- *Parameter 12-03 Default Gateway*
- *Parameter 12-04 DHCP Server*
- *Parameter 12-05 Lease Expires*
- *Parameter 12-06 Name Servers*
- *Parameter 12-07 Domain Name*
- *Parameter 12-08 Host Name*
- *Parameter 12-09 Physical Address*

The PROFINET interface offers several ways of address assignment. Typically, DCP is used, and then the PLC assigns the IP address, subnet mask, and other relevant parameters when the communication is established. The following examples show the settings, if the PROFINET DCP assignment is used.

Parameter	Value
<i>Parameter 12-00 IP Address Assignment</i>	[10] DCP
<i>Parameter 12-01 IP Address</i>	0.0.0.0 (From PLC)
<i>Parameter 12-02 Subnet Mask</i>	0.0.0.0 (From PLC)
<i>Parameter 12-03 Default Gateway</i>	0.0.0.0 (From PLC)
<i>Parameter 12-04 DHCP Server</i>	*

Table 6.2 Setting up Frequency Converter with Manually assigned IP Address

*= *Host Name* can be set via the LCP, Through DCP command or by setting the DIP Switches on the PROFINET interface.

Parameter	Value
<i>Parameter 12-00 IP Address Assignment</i>	[1] DHCP/[2] BOOTP
<i>Parameter 12-01 IP Address</i>	Read only
<i>12-02 Subnet Mask</i>	Read only
<i>Parameter 12-03 Default Gateway</i>	Read only

Table 6.3 Setting up the Frequency Converter with Automatically (BOOTP/DHCP) assigned IP Address

By IP address assigned by DHCP/BOOTP/DCP server, the assigned IP address and subnet mask can be read out in *parameter 12-01 IP Address* and *12-02 Subnet Mask*. In *parameter 12-04 DHCP Server*, the IP address of the found DHCP or BOOTP server is displayed. For DHCP only: The remaining lease-time can be read out in *12-05 Lease Expires*. If lease time is set to 0 (zero), the timer never expires.

12-09 Physical Address reads out the MAC address of option, which is also printed on the label of the option.

Parameter 12-03 Default Gateway is optional and only used in routed networks.

NOTICE

It is only possible to assign valid class A, B, and C IP addresses to the option. The valid ranges are shown in *Table 6.4*.

Class A	1.0.0.1-126.255.255.254
Class B	128.1.0.1-191.255.255.254
Class C	192.0.1.1-223.255.254.254

Table 6.4 Valid Ranges for IP Address to the Option

6.5.2 Ethernet Link Parameters

Parameter group *12-1* Ethernet Link Parameters*:

- *Parameter 12-10 Link Status*
- *12-11 Link Duration*
- *Parameter 12-12 Auto Negotiation*
- *Parameter 12-13 Link Speed*
- *12-14 Link Duplex*

Each port has unique Ethernet Link Parameters.

Parameter 12-10 Link Status and *12-11 Link Duration* displays information on the link status, per port. *Parameter 12-10 Link Status* displays Link or No Link according to the status of the present port. *12-11 Link Duration* displays the duration of the link on the present port. If the link is lost, the counter is reset.

Parameter 12-12 Auto Negotiation enables 2 connected Ethernet devices to select common transmission parameters, such as speed and duplex mode. In this process, the connected devices first share their capabilities and then select the fastest transmission mode they both support.

Incapability between the connected devices could lead to decreased communication performance. To prevent this, auto negotiation can be disabled.

If *parameter 12-12 Auto Negotiation* is set to OFF, link speed and duplex mode can be configured manually in *parameter 12-13 Link Speed* and *parameter 12-12 Auto Negotiation*.

Parameter 12-13 Link Speed - displays/sets the link speed for each port. If no link is present, None is displayed.

12-14 Link Duplex - displays/sets the duplex mode for each port.

6.5.3 PROFINET-specific Parameter List

Parameter	Default value	Range	Conversion index	Data type
8-01 Control Site	[0] Dig. & ctrl. word	[0-2]	-	UInt8
Parameter 8-02 Control Word Source	[0] FC RS485	[0-4]	-	UInt8
Parameter 8-03 Control Word Timeout Time	1	0.1-18000	-1	UInt32
Parameter 8-04 Control Word Timeout Function	[0] Off	[0-10]	-	UInt8
8-05 End-of-Timeout Function	[0] Hold set-up	[0-1]	-	UInt8
Parameter 8-06 Reset Control Word Timeout	[0] Do not reset	[0-1]	-	UInt8
Parameter 8-07 Diagnosis Trigger	[0] Disable	[0-3]	-	UInt8
Parameter 8-10 Control Word Profile	[0] FC profile	[0-x]	-	UInt8
Parameter 8-13 Configurable Status Word STW				
8-50 Coasting Select	[3] *Logic OR	[0-3]	-	UInt8
Parameter 8-51 Quick Stop Select	[3] *Logic OR	[0-3]	-	UInt8
8-52 DC Brake Select	[3] *Logic OR	[0-3]	-	UInt8
8-53 Start Select	[3] *Logic OR	[0-3]	-	UInt8
Parameter 8-54 Reversing Select	[3] *Logic OR	[0-3]	-	UInt8
8-55 Set-up Select	[3] *Logic OR	[0-3]	-	UInt8
8-56 Preset Reference Select	[3] *Logic OR	[0-3]	-	UInt8
8-90 Bus Jog 1 Speed	100 RPM	0-4-13 Motor Speed High Limit [RPM]	67	UInt16
8-91 Bus Jog 2 Speed	200 RPM	0-4-13 Motor Speed High Limit [RPM]	67	UInt16
9-15 PCD Write Configuration	-	-	-	UInt16
9-16 PCD Read Configuration	-	-	-	UInt16
Parameter 9-22 Telegram Selection	-	[0-108]	-	UInt8
Parameter 9-23 Parameters for Signals	-	0-573	-	UInt16
Parameter 9-27 Parameter Edit	[1] Enabled	[0-1]	-	UInt16
9-28 Process Control	[1] Enable cyclic master	[0-1]	-	UInt16
9-44 Fault Message Counter	0	[0-8]	0	UInt16
9-45 Fault Code	0	-	-	UInt16
9-47 Fault Number	0	-	-	UInt16
9-52 Fault Situation Counter	0	0-1000	0	UInt16
9-53 Profibus Warning Word	0	16 bits	0	V2
9-64 Device Identification	0	[0-10]	0	UInt16
9-65 Profile Number	0	8 bits	0	UInt8
9-70 Edit Set-up	[9] Active set-up	[0-9]	-	UInt8
Parameter 9-71 Profibus Save Data Values	[0] Off	[0-2]	-	UInt8
9-72 ProfibusDriveReset	[0] No action	[0-2]	-	UInt8
9-80 Defined Parameters (1)	-	0-115	0	UInt16
9-81 Defined Parameters (2)		0-115	0	UInt16
9-82 Defined Parameters (3)	-	0-115	0	UInt16
9-83 Defined Parameters (4)	-	0-115	0	UInt16
9-90 Changed Parameters (1)	-	0-115	0	UInt16

Parameter	Default value	Range	Conversion index	Data type
9-91 Changed Parameters (2)	-	0-115	0	Uint16
9-92 Changed Parameters (3)	-	0-115	0	Uint16
9-93 Changed Parameters (4)	-	0-115	0	Uint16
12-00 IP Address Assignment	0.0.0.0	0-255	-	Unsigned 8
12-01 IP Address	0.0.0.0	0-255	-	Oct. string 4
Parameter 12-02 Subnet Mask	0.0.0.0	0-255	-	Oct. string 4
12-03 Default Gateway	0.0.0.0	0-255	-	Oct. string 4-
12-04 DHCP Server	0.0.0.0	0-255	-	Oct. string 4
Parameter 12-05 Lease Expires	00:00:00:00	-	-	Time diff. w/ date
Parameter 12-06 Name Servers	0.0.0.0	0-255	-	Oct. string 4
Parameter 12-07 Domain Name	-	max. 19 ch.	-	Visible string 48
12-08 Host Name	-	max. 19 ch.	-	Visible string 48
Parameter 12-09 Physical Address	00:1B:08:00:00:00	-	-	Visible string 17
12-10 Link Status	[0] No Link	[0-1]	-	Unsigned 8
Parameter 12-11 Link Duration	00:00:00:00	-	-	Time diff. w/ date
12-12 Auto Negotiation	[1] On	[0-1]	-	Unsigned 8
12-13 Link Speed	[0] None	[0-2]	-	Unsigned 8
Parameter 12-14 Link Duplex	[1] Full Duplex	[0-1]	-	Unsigned 8[
12-80 FTP Server	[0] Disable	[0-1]	-	Unsigned 8
12-81 HTTP Server	[0] Disable	[0-1]	-	Unsigned 8
12-82 SMTP Service	[0] Disable	[0-1]	-	Unsigned 8
12-89 Transparent Socket Channel Port	[0] Disable	[0-1]	-	Unsigned 8
Parameter 12-90 Cable Diagnostic	[0] Disable	[0-1]	-	Unsigned 8
12-91 Auto Cross Over	[0] Enable	[0-1]	-	Unsigned 8
12-92 IGMP Snooping	[0] Enable	[0-1]	-	Unsigned 8
Parameter 12-93 Cable Error Length	0	0-200	0	Unsigned 16
Parameter 12-94 Broadcast Storm Protection	0	Off-20%	-	Unsigned 16
Parameter 12-95 Broadcast Storm Filter	[1] Enable	[0-31]	-	Unsigned 8
Parameter 12-98 Interface Counters	0	03-365535	-	Unsigned 16
Parameter 12-99 Media Counters	0	0-65535	-	Unsigned 16
16-84 Comm. Option STW	0	0-FFFF	0	V2
16-90 Alarm Word	0	0-FFFF	0	Uint32
16-92 Warning Word	0	0-FFFF	0	Uint32

Table 6.5 PROFINET-specific Parameter List

Refer to the relevant operating instructions for a comprehensive parameter list.

6.6 Object and Data Types Supported

6.6.1 Parameter Description

PROFINET has a number of describing attributes.

6.6.2 Size Attribute

The size index and the conversion index for each parameter can be taken from the parameter list in the respective operating instructions.

Physical unit	Size index	Measuring unit	Designation	Conversion index	Conversion factor
	0	No dimension			
Time	4	second	s	0	1
		millisecond	ms	-1	0.1
		minute	min	-2	0.01
		hour	h	-3	0.001
		day	d	70	60
Energy	8	watthour	Wh	74	3600
		kilowatthour	kWh	77	86400
		megawatthour	MWh	0	1
Power	9	milliwatt	mW	3	1000
		watt	W	6	10 ⁶
		kilowatt	kW	-3	0.001
		megawatt	MW	0	1
Rotation	11	rotation per minute	RPM	3	1000
Torque	16	newtonmetre	Nm	0	1
		kilonewtonmetre	kNm	3	1000
Temperature	17	degree Celsius	°C	0	1
Voltage	21	millivolt	mV	-3	0.001
		volt	V	0	1
		kilovolt	kV	3	1000
Current	22	milliampere	mA	-3	0.001
		ampere	A	0	1
		kiloampere	kA	3	1000
Resistance	23	milliohm	mOhm	-3	0.001
		ohm	Ohm	0	1
		kiloohm	kOhm	3	1000
Ratio	24	per cent	%	0	1
Relative change	27	per cent	%	0	1
Frequency	28	hertz	Hz	0	1
		kilohertz	kHz	3	1000
		megahertz	MHz	6	10 ⁶
		gigahertz	GHz	9	10 ⁹

Table 6.6 Size Index and Conversion Index

6.6.3 Object and Data Types Supported

Data type	Short name	Description
3	I2	Integer 16
4	I4	Integer 32
5	-	Unsigned 8
6	O2	Unsigned 16
7	O4	Unsigned 32
9	-	Visible string
10	-	Byte string
33	N2	Standardised value (16 bit)
35	V2	Bit sequence
54	-	Time difference without date indication

Table 6.7 Data Types Supported

7 Application Examples

7.1 Example: Process Data with PPO Type 6

This example shows how to work with PPO type 6, which consists of control word/status word and reference/main actual value. The PPO also has 2 additional words, which can be programmed to monitor process signals, see *Table 7.1*:

	0		1		2		3	
	CTW		MRV		PCD [2]		PCD	
From controller	04	7C	20	00	00	00	00	00
	STW		MAV		PCD [2]		PCD [3]	
From frequency converter	0F	07	20	00	3F	A6	00	08
Byte #	1	2	3	4	5	6	7	8

Table 7.1 Example: Process Data with PPO Type 6

The application requires monitoring of the motor torque and digital input, so PCD 2 is set up to read the current motor torque. PCD 3 is set up to monitor the state of an external sensor via the process signal digital input. The sensor is connected to digital input 18.

An external device is also controlled via control word bit 11 and the built-in relay of the frequency converter. Reversing is permitted only when the reversing bit 15 in the control word and the digital input 19 are set to high.

For safety reasons, the frequency converter stops the motor if the PROFINET cable is broken, the master has a system failure, or the PLC is in stop mode.

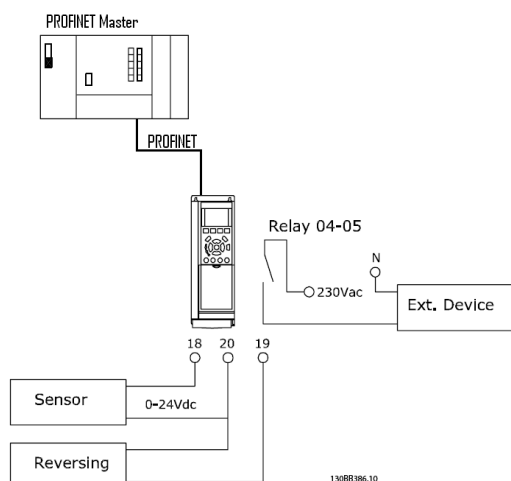

Illustration 7.1 Wiring Diagram

Program the frequency converter as shown in *Table 7.2*:

Parameter	Setting
4-10 Motor Speed Direction	[2] Both directions
5-10 Terminal 18 Digital Input	[0] No operation
5-11 Terminal 19 Digital Input	[10] Reversing
5-40 Function Relay	[36/37] Control word bit 11/12
Parameter 8-03 Control Word Timeout Time	1 s
Parameter 8-04 Control Word Timeout Function	[2] Stop
Parameter 8-10 Control Word Profile	[0] FC Profile
8-50 Coasting Select	[1] Bus
Parameter 8-51 Quick Stop Select	[1] Bus
8-52 DC Brake Select	[1] Bus
8-53 Start Select	[1] Bus
Parameter 8-54 Reversing Select	[2] Logic AND
8-55 Set-up Select	[1] Bus
8-56 Preset Reference Select	[1] Bus
9-16 PCD Read Configuration	[2] Sub index 16-16 Torque [Nm] [3] Sub index 16-60 Digital Input

Table 7.2 Parameter Settings

7.2 Example: Control Word Telegram using Standard Telegram 1/PPO3

This example shows how the control word telegram relates to the controller and the frequency converter, using FC control profile.

The control word telegram is sent from the PLC to the frequency converter. Standard telegram 1 is used in the example to demonstrate the full range of modules. All the values shown are arbitrary, and are provided for the purposes of demonstration only.

	0		1		2		3																									
	CTW		MRV		PCD		PCD																									
	04	7C	20	00																												
PQW:	256		258		260		262																									
	CTW		MRV																													
Bit no.:	31	30	29	28	27	26	25	24	23	22	21	20	19	18	17	16	15	14	13	12	11	10	9	8	7	6	5	4	3	2	1	0
	0	0	0	0	0	1	0	0	0	1	1	1	1	1	0	0	0	0	0	1	0	0	0	0	0	0	0	0	0	0	0	0
	0				4				7				C				2				0				0				0			

Table 7.3 PCD

Table 7.3 indicates the bits contained within the control word, and how they are presented as process data in standard telegram 1 for this example.

Table 7.4 indicates which bit functions, and which corresponding bit values are active for this example.

Bit	Bit value=0	Bit value=1	Bit value	
00	Reference value	External selection lsb	0	C
01	Reference value	External selection msb	0	
02	DC brake	Ramp	1	
03	Coasting	Enable	1	
04	Quick stop	Ramp	1	7
05	Freeze output	Ramp enable	1	
06	Ramp stop	Start	1	
07	No function	Reset	0	
08	No function	Jog	0	4
09	Ramp 1	Ramp 2	0	
10	Data not valid	Valid	1	
11	No function	Relay 01 active	0	
12	No function	Relay 02 active	0	0
13	Parameter set-up	Selection lsb	0	
14	Parameter set-up	Selection msb	0	
15	No function	Reversing	0	
Function active				
Function inactive				

Table 7.4 Control Word Telegram using Standard Telegram 1/PPO3

7.3 Example: Status Word Telegram using Standard Telegram 1/PPO3

This example shows how the control word telegram relates to the PLC and the frequency converter, using FC control profile.

The control word telegram is sent from the frequency converter to the controller. Standard telegram 1 is used in the example to demonstrate the full range of modules. All the values shown are arbitrary, and are provided for demonstration purposes only.

	0		1		2		3																									
	STW		MAV		PCD		PCD																									
	0F	07	20	00																												
PIW:	256		258		260		262																									
	STW		MAV																													
Bit no.:	31	30	29	28	27	26	25	24	23	22	21	20	19	18	17	16	15	14	13	12	11	10	9	8	7	6	5	4	3	2	1	0
	0	0	0	0	0	1	0	0	0	1	1	1	1	1	0	0	0	0	0	1	0	0	0	0	0	0	0	0	0	0	0	0
	0				F				0				7				2				0				0				0			

Table 7.5 PCD

7

Table 7.5 indicates the bits contained within the status word, and how they are presented as process data in standard telegram 1 for this example.

Table 7.6 indicates which bit functions, and which corresponding bit values are active for this example.

Bit	Bit value=0	Bit value=1	Bit value	
00	Control not ready	Control ready	1	7
01	Drive not ready	Drive ready	1	
02	Coasting	Enable	1	
03	No error	Trip	0	
04	No error	Error (no trip)	0	0
05	Reserved	-	0	
06	No error	Triplock	0	
07	No warning	Warning	0	
08	Speed reference	Speed#=#reference	1	F
09	Local operation	Bus control	1	
10	Outside frequency range	Within frequency range	1	
11	No operation	In operation	1	
12	Drive ok	Stopped, autostart	0	0
13	Voltage ok	Voltage exceeded	0	
14	Torque ok	Torque exceeded	0	
15	Timers ok	Timers exceeded	0	
Function active				
Function inactive				

Table 7.6 Status Word Telegram using Standard Telegram 1/PPO3

7.4 Example: PLC Programming

In this example, PPO type 6 is placed in the following input/output address:

Slot	Module	Order Number	I Address	Q address	Diagnostic address	Comment
0	FC302	130B1135			2042*	
X1	Interface				2041*	
X1	Port 1				2040*	
1	PPO Type 6 PCD	130B1135			2039*	
1.1	Parameter Access Point				2039*	
1.2	PPO Type 6 PCD		256...263	256...263		

Input address	256–257	258–259	260–261	262–263	Output address	256–257	258–259	260–261	262–263
Set-up	Status word	MAV	Motor torque	Digital input	Set-up	Control word	Reference	Not used	Not used

Illustration 7.2 PPO Type 6 Placed in the Input/Output Address

This network sends a start command (047C hex) and a reference (2000 hex) of 50% to the frequency converter.

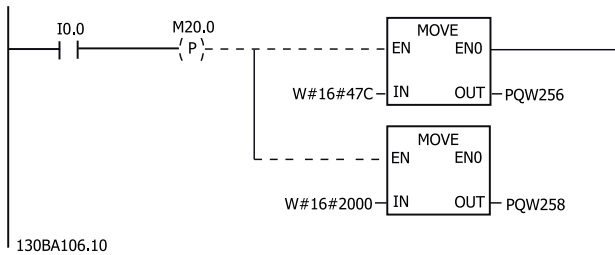

Illustration 7.3 Network Sends Start Command and Reference

This network reads the motor torque from the frequency converter. A new reference is sent to the frequency converter because the motor torque (86.0%) is higher than the compared value.

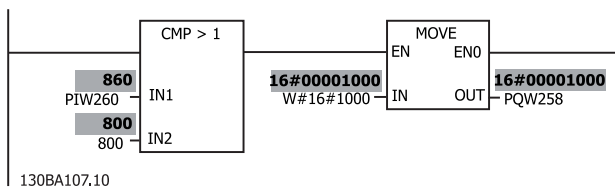

Illustration 7.4 Network Reads the Motor Torque

This network reads the status on the digital inputs from the frequency converter. If digital input 18 is ON, it stops the frequency converter.

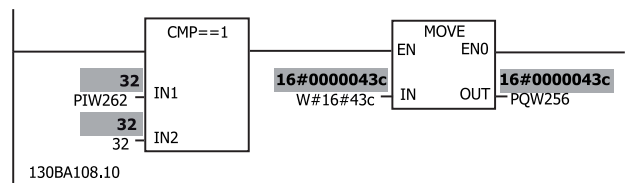

Illustration 7.5 Network Reads the Status on the Digital Inputs

This network reverses the motor when digital input 19 is ON, because *parameter 8-54 Reversing Select* is programmed to Logic AND.

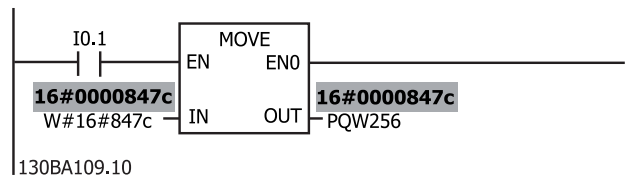

Illustration 7.6 Network Reverses the Motor

This network activates relay 02.

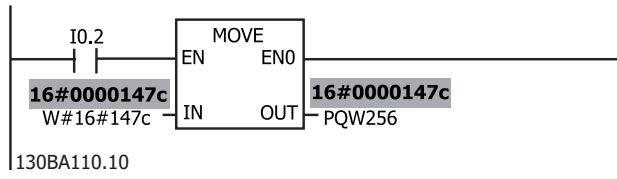

Illustration 7.7 Network Activates Relay 02

8 Troubleshooting

8.1 No Response to Control Signals

Check 1: Is the control word valid?

If bit 10=0 in the control word, the frequency converter does not accept the control word.

Check 2: Is the relationship between bits in the control word and the terminal I/Os correct?

Check the logical relationship in the frequency converter.

Define the desired logical relationship in *8-50 Coasting Select* to *8-56 Preset Reference Select* according to the following range of options. Select the FC control mode, digital input and/or serial communication, using *8-50 Coasting Select* to *8-56 Preset Reference Select*.

If *8-01 Control Site* is set to digital only, the frequency converter does not react on commands sent via the control word.

Table 8.1 to *Table 8.8* show a coast command's effect upon the frequency converter for the full range of *8-50 Coasting Select* settings.

The effect of control mode upon the function of *8-50 Coasting Select*, *parameter 8-51 Quick Stop Select*, and *8-52 DC Brake Select* is as follows:

If *[0] Digital input* is selected, the terminals control the coast and DC brake functions.

NOTICE

Coasting, quick stop, and DC brake functions are active for logic 0.

Terminal	Bits 02/03/04	Function
0	0	Coast/DC brake/Q-Stop
0	1	Coast/DC brake/Q-Stop
1	0	No Coast/DC brake/Q-Stop
1	1	No Coast/DC brake/Q-Stop

Table 8.1 [0] Digital Input

If *[1] Serial communication* is selected, commands are activated only when given via serial communication.

Terminal	Bits 02/03/04	Function
0	0	Coast/DC brake/Q-Stop
0	1	No Coast/DC brake/Q-Stop
1	0	Coast/DC brake/Q-Stop
1	1	No Coast/DC brake/Q-Stop

Table 8.2 [1] Serial Communication

If *[2] Logic AND* is selected, both signals must be activated to perform the function.

Terminal	Bits 02/03/04	Function
0	0	Coast/DC brake/Q-Stop
0	1	No Coast/DC brake/Q-Stop
1	0	No Coast/DC brake/Q-Stop
1	1	No Coast/DC brake/Q-Stop

Table 8.3 [2] Logic AND

If *[3] Logic OR* is selected, activation of one signal activates the function.

Terminal	Bits 02/03/04	Function
0	0	Coast/DC brake/Q-Stop
0	1	Coast/DC brake/Q-Stop
1	0	Coast/DC brake/Q-Stop
1	1	No Coast/DC brake/Q-Stop

Table 8.4 [3] Logic OR

The effect of control mode upon the function of *8-53 Start Select* and *parameter 8-54 Reversing Select*:

If *[0] Digital input* is selected, the terminals control the start and reversing functions

Terminal	Bits 06/15	Function
0	0	Stop/Counterclockwise
0	1	Stop/Counterclockwise
1	0	Start/Clockwise
1	1	Start/Clockwise

Table 8.5 [0] Digital input

If *[1] Serial communication* is selected, commands are activated only when given via serial communication.

Terminal	Bits 02/03/04	Function
0	0	Stop/Counterclockwise
0	1	Start/Clockwise
1	0	Stop/Counterclockwise
1	1	Start/Clockwise

Table 8.6 [1] Serial Communication

If [2] *Logic AND* is selected, both signals must be activated to perform the function.

Terminal	Bits 02/03/04	Function
0	0	Stop/Counterclockwise
0	1	Stop/Counterclockwise
1	0	Stop/Counterclockwise
1	1	Start/Clockwise

Table 8.7 [2] Logic AND

If [3] *Logic OR* is selected, activation of one signal activates the function.

Terminal	Bits 02/03/04	Function
0	0	Stop/Counterclockwise
0	1	Start/Clockwise
1	0	Start/Clockwise
1	1	Start/Clockwise

Table 8.8 [3] Logic OR

The effect of control mode upon the function of 8-55 *Set-up Select* and 8-56 *Preset Reference Select*:

If [0] *Digital input* is selected, the terminals control the set-up and preset reference functions.

Terminal		Bits 00/01, 13/14		Function
Msb	Lsb	Msb	Lsb	Preset ref. set-up number
0	0	0	0	1
0	0	0	1	1
0	0	1	0	1
0	0	1	1	1
0	1	0	0	2
0	1	0	1	2
0	1	1	0	2
0	1	1	1	2
1	0	0	0	3
1	0	0	1	3
1	0	1	0	3
1	0	1	1	3
1	1	0	0	4
1	1	0	1	4
1	1	1	0	4
1	1	1	1	4

Table 8.9 [0] Digital Input

If [1] *Serial communication* is selected, commands are activated only when given via serial communication.

Terminal		Bits 00/01, 13/14		Function
Msb	Lsb	Msb	Lsb	Preset ref. set-up number
0	0	0	0	1
0	0	0	1	2
0	0	1	0	3
0	0	1	1	4
0	1	0	0	1
0	1	0	1	2
0	1	1	0	3
0	1	1	1	4
1	0	0	0	1
1	0	0	1	2
1	0	1	0	3
1	0	1	1	4
1	1	0	0	1
1	1	0	1	2
1	1	1	0	3
1	1	1	1	4

Table 8.10 [1] Serial Communication

If [2] *Logic AND* is selected, both signals must be activated to perform the function.

Terminal		Bits 00/01, 13/14		Function
Msb	Lsb	Msb	Lsb	Preset ref. set-up number
0	0	0	0	1
0	0	0	1	1
0	0	1	0	1
0	0	1	1	1
0	1	0	0	1
0	1	0	1	2
0	1	1	0	1
0	1	1	1	2
1	0	0	0	1
1	0	0	1	1
1	0	1	0	3
1	0	1	1	3
1	1	0	0	1
1	1	0	1	2
1	1	1	0	3
1	1	1	1	4

Table 8.11 [2] Logic AND

If [3] Logic OR is selected, activation of 1 signal activates the function.

Terminal		Bits 00/01, 13/14		Function
Msb	LSb	Msb	LSb	Preset ref. set-up number
0	0	0	0	1
0	0	0	1	2
0	0	1	0	3
0	0	1	1	4
0	1	0	0	2
0	1	0	1	2
0	1	1	0	4
0	1	1	1	4
1	0	0	0	3
1	0	0	1	4
1	0	1	0	3
1	0	1	1	4
1	1	0	0	4
1	1	0	1	4
1	1	1	0	4

Table 8.12 [3] Logic OR

8.2 Warnings and Alarms

PROFINET alarm words and warning words are shown on the display in hex format. If there is more than 1 warning or alarm, a sum of all warnings or alarms show. Alarm word, warning word, and, PROFINET warning word can also be displayed using the serial bus in 16-90 Alarm Word, 16-92 Warning Word, and 9-53 Profibus Warning Word.

Bit (hex)	Unit diagnose bit	Alarm word (16-90 Alarm Word)	Alarm number
00000001	48	Brake check	28
00000002	49	Power card over temperature	29
00000004	50	Earth fault	14
00000008	51	Control card over temperature	65
00000010	52	Control word time-out	18
00000020	53	Overcurrent	13
00000040	54	Torque limit	12
00000080	55	Motor thermistor over temp.	11
00000100	40	Motor ETR over temperature	10
00000200	41	Inverter overloaded	9
00000400	42	DC-link undervoltage	8
00000800	43	DC-link overvoltage	7
00001000	44	Short circuit	16
00002000	45	Inrush fault	33
00004000	46	Mains phase loss	4
00008000	47	AMA not OK	50
00010000	32	Live zero error	2
00020000	33	Internal fault	38
00040000	34	Brake overload	26
00080000	35	Motor phase U is missing	30
00100000	36	Motor phase V is missing	31
00200000	37	Motor phase W is missing	32
00400000	38	Fieldbus comm. fault	34
00800000	39	24 V supply fault	47
01000000	24	Mains failure	36
02000000	25	1.8 V supply fault	48
04000000	26	Brake resistor short circuit	25
08000000	27	Brake chopper fault	27
10000000	28	Option change	67
20000000	29	Drive initialisation	80
40000000	30	Safe stop	68
80000000	31	Mechanical brake low	63

Table 8.13 16-90 Alarm Word

Bit (hex)	Unit diagnose bit	Warning word (16-92 Warning Word)	Alarm number
00000001	112	Brake check	28
00000002	113	Power card over temperature	29
00000004	114	Earth fault	14
00000008	115	Control card	65
00000010	116	Control word timeout	18
00000020	117	Overcurrent	13
00000040	118	Torque limit	12
00000080	119	Motor thermistor over temp.	11
00000100	104	Motor ETR over temperature	10
00000200	105	Inverter overloaded	9
00000400	106	DC-link undervoltage	8
00000800	107	DC-link overvoltage	7
00001000	108	DC-link voltage low	6
00002000	109	DC-link voltage high	5
00004000	110	Mains phase loss	4
00008000	111	No motor	3
00010000	96	Live zero error	2
00020000	97	10 V low	1
00040000	98	Brake overload	26
00080000	99	Brake resistor short circuit	25
00100000	100	Brake chopper fault	27
00200000	101	Speed limit	49
00400000	102	Fieldbus comm. fault	34
00800000	103	24 V supply fault	47
01000000	88	Mains failure	36
02000000	89	Current limit	59
04000000	90	Low temperature	66
08000000	91	Voltage limit	64
10000000	92	Encoder loss	61
20000000	93	Output frequency limit	62
40000000	94	Unused	-
80000000	95	Warning word 2 (ext. stat. word)	-

Table 8.14 16-92 Warning Word

Bit (hex)	Unit diagnose bit	PROFIBUS warning word (9-53 Profibus Warning Word)
00000001	160	Connection with DP-master is not ok
00000002	161	Unused
00000004	162	FDL (Fieldbus Data link Layer) is not ok
00000008	163	Clear data command received
00000010	164	Actual value is not updated
00000020	165	Baudrate search
00000040	166	PROFIBUS ASIC is not transmitting
00000080	167	Initialising of PROFIBUS is not ok
00000100	152	Drive is tripped
00000200	153	Internal CAN error
00000400	154	Wrong configuration data from PLC
00000800	155	Wrong ID sent by PLC
00001000	156	Internal error occurred
00002000	157	Not configured
00004000	158	Time-out active
00008000	159	Warning 34 active

Table 8.15 9-53 Profibus Warning Word

Bit (Hex)	Comm. option STW (16-84 Comm. Option STW)
00000001	parameterisation ok
00000002	configuration ok
00000004	clearmode active
00000008	baudrate search
00000010	waiting for parameterisation
00000020	waiting for configuration
00000040	in data exchange
00000080	not used
00000100	not used
00000200	not used
00000400	not used
00000800	MCL2/1 connected
00001000	MCL2/2 connected
00002000	MCL2/3 connected
00004000	data transport active
00008000	not used

Table 8.16 16-84 Comm. Option STW

NOTICE

16-84 Comm. Option STW is not part of extended diagnosis.

8.2.1 Warning and Alarm Messages

The LEDs on the LCP signals a warning or an alarm. A code in the display is also shown.

A warning remains active until its cause is no longer present. Under certain circumstances, operation of the

motor can still be continued. Warning messages are not necessarily critical.

An alarm makes the frequency converter trip. Alarms must be reset to restart operation once their cause has been rectified.

3 ways of resetting alarms

- By pressing [Reset].
- Via a digital input with the Reset function.
- Via serial communication/optional fieldbus.

NOTICE

After a manual reset pressing [Reset], press [Auto On] to restart the motor.

If an alarm cannot be reset, the reason could be that its cause has not been rectified, or the alarm is trip-locked (see also *Table 8.17*).

Alarms that are trip-locked offer additional protection, meaning that the mains supply must be switched off before the alarm can be reset. After being switched back on, the frequency converter is no longer blocked and can be reset as described, once the cause has been rectified.

Alarms that are not trip-locked can also be reset using the automatic reset function in *14-20 Reset Mode* (Warning: automatic wake-up is possible!)

When a warning or alarm is marked against a code in *Table 8.17*, this means that either a warning occurs before an alarm, or that it is possible to specify whether it is a warning or an alarm that is displayed for a given fault.

It is possible, for instance, in *1-90 Motor Thermal Protection*. After an alarm or trip, the motor carries on coasting, and the alarm and warning flash. Once the problem has been rectified, only the alarm continues flashing until the frequency converter is reset.

8.2.2 Alarm and Warning List

Number	Description	Warning	Alarm/trip	Alarm/trip lock	Parameter reference
1	10 V low	X			
2	Live zero error	(X)	(X)		<i>6-01 Live Zero Timeout Function</i>
3	No motor	(X)			<i>1-80 Function at Stop</i>
4	Mains phase loss	(X)	(X)	(X)	<i>14-12 Function at Mains Imbalance</i>
5	DC link voltage high	X			
6	DC link voltage low	X			
7	DC overvoltage	X	X		
8	DC undervoltage	X	X		
9	Inverter overloaded	X	X		
10	Motor ETR overtemperature	(X)	(X)		<i>1-90 Motor Thermal Protection</i>
11	Motor thermistor overtemperature	(X)	(X)		<i>1-90 Motor Thermal Protection</i>
12	Torque limit	X	X		
13	Overcurrent	X	X	X	
14	Earth fault	X	X	X	
15	Hardware mismatch		X	X	
16	Short circuit		X	X	
17	Control word time-out	(X)	(X)		<i>Parameter 8-04 Control Word Timeout Function</i>
22	Hoist mech. brake				
23	Internal fan fault	X			
24	External fan fault	X			<i>14-53 Fan Monitor</i>
25	Brake resistor short-circuited	X			
26	Brake resistor power limit	(X)	(X)		<i>2-13 Brake Power Monitoring</i>
27	Brake chopper short-circuited	X	X		
28	Brake check	(X)	(X)		<i>2-15 Brake Check</i>
29	Heat sink temp	X	X	X	
30	Motor phase U missing	(X)	(X)	(X)	<i>4-58 Missing Motor Phase Function</i>
31	Motor phase V missing	(X)	(X)	(X)	<i>4-58 Missing Motor Phase Function</i>
32	Motor phase W missing	(X)	(X)	(X)	<i>4-58 Missing Motor Phase Function</i>
33	Inrush fault		X	X	

Number	Description	Warning	Alarm/trip	Alarm/trip lock	Parameter reference
34	Fieldbus communication fault	X	X		
36	Mains failure	X	X		
38	Internal fault		X	X	
39	Heat sink sensor		X	X	
40	Overload of digital output terminal 27	(X)			5-00 Digital I/O Mode, 5-01 Terminal 27 Mode
41	Overload of digital output terminal 29	(X)			5-00 Digital I/O Mode, 5-02 Terminal 29 Mode
42	Overload of digital output on X30/6	(X)			5-32 Term X30/6 Digi Out (MCB 101)
42	Overload of digital output on X30/7	(X)			5-33 Term X30/7 Digi Out (MCB 101)
46	Pwr. card supply		X	X	
47	24 V supply low	X	X	X	
48	1.8 V supply low		X	X	
49	Speed limit	X			
50	AMA calibration failed		X		
51	AMA check U_{nom} and I_{nom}		X		
52	AMA low I_{nom}		X		
53	AMA motor too big		X		
54	AMA motor too small		X		
55	AMA parameter out of range		X		
56	AMA interrupted by user		X		
57	AMA time-out		X		
58	AMA internal fault	X	X		
59	Current limit	X			
61	Tracking error	(X)	(X)		4-30 Motor Feedback Loss Function
62	Output frequency at maximum limit	X			
63	Mechanical brake low		(X)		2-20 Release Brake Current
64	Voltage limit	X			
65	Control board overtemperature	X	X	X	
66	Heat sink temperature low	X			
67	Option configuration has changed		X		
68	Safe stop	(X)	(X) ¹⁾		5-19 Terminal 37 Safe Stop
69	Pwr. card temp		X	X	
70	Illegal FC configuration			X	
71	PTC 1 safe stop	X	X ¹⁾		5-19 Terminal 37 Safe Stop
72	Dangerous failure			X ¹⁾	5-19 Terminal 37 Safe Stop
73	Safe stop auto restart				
77	Reduced power mode	X			14-59 Actual Number of Inverter Units
79	Illegal PS config		X	X	
80	Frequency converter Initialised to default value		X		
81	CSIV corrupt				
82	CSIV parameter error				
85	Profibus/Profisafe error				
90	Encoder loss	(X)	(X)		17-61 Feedback Signal Monitoring
91	Analogue input 54 wrong settings			X	S202
100-199	See <i>Operating Instructions for MCO 305</i>				
243	Brake IGBT	X	X		
244	Heat sink temp	X	X	X	

Number	Description	Warning	Alarm/trip	Alarm/trip lock	Parameter reference
245	Heat sink sensor		X	X	
246	Pwr.card supply		X	X	
247	Pwr.card temp		X	X	
248	Illegal PS config		X	X	
250	New spare part			X	14-23 Typecode Setting
251	New type code		X	X	

Table 8.17 Alarm/Warning Code List

(X) Dependent on parameter

1) Cannot be auto reset via 14-20 Reset Mode

A trip is the action when an alarm has appeared. The trip coasts the motor and can be reset by pressing [Reset] or by making a reset by a [1] digital input (Parameter group 5-1* Digital I/O Mode). The event that caused an alarm cannot damage the frequency converter or cause dangerous conditions. A trip lock is an action when an alarm occurs, that can damage the frequency converter or connected parts. A trip lock situation can only be reset by a power cycling.

Warning	yellow
Alarm	flashing red
Trip locked	yellow and red

Table 8.18 LED Indication

Bit	Hex	Dec	Alarm word	Alarm word 2	Warning word	Warning word 2	Extended status word
0	00000001	1	Brake check	ServiceTrip, Read/Write	Brake check		Ramping
1	00000002	2	Pwr. card temp	ServiceTrip, (reserved)	Pwr. card temp		AMA running
2	00000004	4	Earth fault	ServiceTrip, Typecode/ Sparepart	Earth fault		Start CW/CCW
3	00000008	8	Ctrl.card temp	ServiceTrip, (reserved)	Ctrl.card temp		Slow down
4	00000010	16	Ctrl. word TO	ServiceTrip, (reserved)	Ctrl. word TO		Catch up
5	00000020	32	Overcurrent		Overcurrent		Feedback high
6	00000040	64	Torque limit		Torque limit		Feedback low
7	00000080	128	Motor Th over		Motor Th over		Output current high
8	00000100	256	Motor ETR over		Motor ETR over		Output current low
9	00000200	512	Inverter overl.		Inverter overl.		Output freq high
10	00000400	1024	DC undervolt		DC undervolt		Output freq low
11	00000800	2048	DC overvolt		DC overvolt		Brake check OK
12	00001000	4096	Short circuit		DC voltage low		Braking max
13	00002000	8192	Inrush fault		DC voltage high		Braking
14	00004000	16384	Mains ph. loss		Mains ph. loss		Out of speed range
15	00008000	32768	AMA not OK		No motor		OVC active
16	00010000	65536	Live zero error		Live zero error		AC brake
17	00020000	131072	Internal fault	KTY error	10 V low	KTY Warn	Password timelock
18	00040000	262144	Brake overload	Fans error	Brake overload	Fans Warn	Password protection
19	00080000	524288	U phase loss	ECB error	Brake resistor	ECB Warn	
20	00100000	1048576	V phase loss		Brake IGBT		
21	00200000	2097152	W phase loss		Speed limit		
22	00400000	4194304	Fieldbus fault		Fieldbus fault		Unused
23	00800000	8388608	24 V supply low		24 V supply low		Unused
24	01000000	16777216	Mains failure		Mains failure		Unused
25	02000000	33554432	1.8 V supply low		Current limit		Unused
26	04000000	67108864	Brake resistor		Low temp		Unused
27	08000000	134217728	Brake IGBT		Voltage limit		Unused
28	10000000	268435456	Option change		Encoder loss		Unused
29	20000000	536870912	Drive Initialised		Output freq. lim.		Unused
30	40000000	1073741824	Safe stop (A68)	PTC 1 Safe stop (A71)	Safe stop (W68)	PTC 1 Safe stop (W71)	Unused
31	80000000	2147483648	Mech. brake low	Dangerous failure (A72)	Extended status word		Unused

Table 8.19 Description of Alarm Word, Warning Word, and Extended Status Word

The alarm words, warning words and extended status words can be read out via serial bus or optional fieldbus for diagnose. See also *16-94 Ext. Status Word*.

Index

A	
Abbreviation.....	4
Acyclic.....	23
Additional resources.....	3
Alarm.....	52
Alarm word.....	51
Approval.....	0
C	
Cabling.....	37
Certification.....	0
Configuration.....	4, 28
Control profile.....	16
Control word.....	16
Convention.....	4
CTW.....	16
D	
Data block.....	26
Data types supported.....	43
Discharge time.....	5
E	
Ethernet.....	36, 37, 39
F	
FC control mode	
Digital input terminals.....	16
G	
GSDML file.....	7
H	
High voltage.....	5
I	
I/O.....	4
L	
Leakage current.....	6
LED.....	4
Load sharing.....	5
M	
MRV.....	13
N	
Network.....	36, 37
No response to control signals.....	49
P	
Parameter.....	39
PCA handling.....	11
PCA parameter characteristic.....	11
PCD.....	13
PCV.....	13
PCV parameter access.....	11
PPO types.....	10
Process control data.....	14
Process control operation.....	16
Process data.....	14
Process status data.....	14
PROFIdrive profile (CTW).....	16
PROFIdrive state transition diagram.....	19
Q	
Qualified personnel.....	5
R	
RC content.....	12
Reference.....	4
Reference handling.....	15
Request/response handling.....	12
S	
Safety.....	6
Size attribute.....	42
Status word.....	17
Symbol.....	4
U	
Unintended start.....	5
V	
VLT parameter.....	9
W	
Warning.....	52
Warning word.....	51



.....
Danfoss can accept no responsibility for possible errors in catalogues, brochures and other printed material. Danfoss reserves the right to alter its products without notice. This also applies to products already on order provided that such alterations can be made without subsequential changes being necessary in specifications already agreed. All trademarks in this material are property of the respective companies. Danfoss and the Danfoss logotype are trademarks of Danfoss A/S. All rights reserved.
.....

Danfoss A/S
Ulsnaes 1
DK-6300 Graasten
www.danfoss.com/drives

